



MARKSUSA

2018 Price List

Mortise Locksets

**Cylindrical, Tubular & Electronic
Access Control Locksets**

Exit Devices



Revised September 2018

MORTISE LOCKSET PRICE LIST • EFFECTIVE SEPTEMBER 2016

TABLE OF CONTENTS

Required Information	6
Backset	6
Door Thickness	6
Handing	6
Mounts & Displays	6
Mortise Lock Trim Information	7
Handleset Trim	7
Lever/Knobset Trim	7
How To Order Mortise Locksets & Handlesets	8-10
How To Order Instructions & Examples	8
1. Series	9
2. Plates/Roses/Handlesets	9
3. Knob/Lever	9
4. Mortise Functions	9
5. Finishes	9
6. Options	10
Plate Designs	11-27
Barrier - BA	11
Classic - CL	12-13
Capitol - CP	14-15
Crown - CR	16-17
Drake - DR	18-19
Davos - DV	20-21
Madison - MA	22-23
New Yorker - NY	24-25
Towne - TN	26-27
Rose Designs	28-29
Rose with Ring - RR	28-29
Plain Rose - RW	28-29
Small Rose with Ring - RQ	28-29
Small Rose - RS	28-29
Square Rose - RX	28-29
Square Rose - RK	28-29
Square Rose - RL	28-29
Handleset Designs	30-31
Crown - CR	30
Towne - TN	32
Ornamental Iron	32-33
Series 21 Unilock™	32
Series 22	32
Series 9215 Unilock™	32
Series 9225	32
Series 9257 Unilock™	32
Series 9267	32
THINLINE® Series 2750	32
Knob & Lever Kits	33
Accessories	33
Cylinders	33

MORTISE LOCKSET PRICE LIST

Mortise Parts & Trim	34-46
Mortise Lock Bodies Series 4 & 45	34
Mortise Lock Bodies Series 5 & 55	35
Mortise Lock Bodies Series 6 & 8	36
Mortise Lock Bodies Series 7 & 9	37
Mortise Deadlocks Series 31, 2, 3, 5 & 55	38
Mortise Lockset Functions	39-40
Mortise Lock Parts: Knob/Lever Rose Kits	41
Mortise Lock Parts: Dummy Cylinder, Collars & Turnpieces, Strikes, Spindles	42
Trim Lock Parts: How to Order	43
Trim Lock Parts: Plate/Rose Design	44
Trim Lock Parts: Knob/Lever Design	45
Trim Lock Parts: Handle Design	46
Mortise Door Accessories	46

CYLINDRICAL & TUBULAR LOCKSET PRICE LIST

How To Order Cylindrical Locksets	47
How To Order Example For Cylindrical Locksets	47
1. Series	47
2. Cylindrical Functions	47
3. Finishes	47
4. Options	47
Cylindrical Locksets	48-51
80 Line Grade 1 Cylindrical Knobsets	48
10 Line Grade 2 Cylindrical Knobsets	49
95 Line Grade 1 Cylindrical Survivor Series Leversets	50
75 Line Grade 2 Cylindrical Survivor Series Leversets	51
Residential Interior Cylindrical Locksets	52
1120 Series Grade 2 Knobsets (<i>cylindrical knobsets for interior use</i>)	52
230 Series Knobsets (<i>cylindrical knobsets for interior use</i>)	52
Cylindrical Lock Accessories	53
Latches, Strikes, Spacer Rings, Etc.	53
Marks Survivor Series Lock Installation Tool J295	53
Cylinders, Cylindrical Lock Tailpieces, Cylindrical IC Core Tailpieces	53
How to order example for Cylindrical Lock Cylinders & Tailpieces	53
Cylindrical Knob/Lever Functions	54
How To Order Tubular Locksets	55
How To Order Example For Tubular Locksets	55
1. Series	55
2. Roses	55
3. Knob/Lever	55
4. Tubular Function	55
5. Finishes	55
6. Options	55
Tubular Knob & Lever Functions	55
Rose Designs	56
Rose with Ring - RR	56
Plain Rose - RW	56
Small Rose with Ring - RQ	56
Small Rose - RS	56
Square Rose - RX	56
Square Rose - RK	56
Square Rose - RL	56
Residential Interior Tubular Locksets	57
150 Series American Lever (<i>tubular leversets for interior use</i>)	57
250 Series Crescent Lever (<i>tubular leversets for interior use</i>)	57
450 Series Titan Lever (<i>tubular leversets for interior use</i>)	57
Tubular Lockset Accessories	58
Strikes, Latches, Support Housing	58
Turnpieces	58
Latches & Cylindrical Cartridge	58
How To Order For Defender Locksets	59
How To Order Example For Defender Locksets	59
1. Series	59
2. Tubular Functions	59
3. Finishes	59
4. Options	59
Deadbolt/Deadlatch Functions	59

CYLINDRICAL & TUBULAR LOCKSET PRICE LIST

Defender Series Tubular Deadbolts & Cylindrical Cartridge Deadlatches	60
130 Series Grade 1 Defender Tubular Deadbolts	60
145 Series Grade 1 Defender Cylindrical Cartridge Deadlatches	60
Defender Series Accessories	61
Strikes, Latches & Spacers	61
Latches & Cylindrical Cartridge	61
Tailpieces & Cylinders	61
i-Qwik/i-Que Electronic Access Control Locksets	62-64
i-Qwik LITE ² Series Electronic Access Control & How To Order Example	62
i-Qwik/i-Que Series Options	63
i-Qwik/i-Que Series Accessories, Tailpieces & Cams	64
Request To EXit (REX) Leversets & Electrified Locksets	65-66
Request To EXit (REX) Cylindrical Grade 1 Leversets (EA195, EA295, EA395 & EA495)	65
How To Order Example For REX Leversets	65
195, 295, 395 & 495 Series Grade 1 Electrified Cylindrical Leversets	66
5 Series Grade 1 Electrified Mortise Lockset	66
Gate Locks	67
Swinging Gate Locks	67
Sliding Gate Locks	67
Parts	67
Custom Lockset Division	68-70
Series HA113 Housing Authority Mortise Lockset	68
Series LA318GJ Maximum Security Mortise Lockset	69
Series BE101 & LA3118	70
Institutional Life Safety Mortise Locksets	71-73
Series 195SS Institutional Life Safety Cylindrical Lever Lockset	71
Series 5SS55 & 5SS19 Institutional Life Safety Mortise Knob & Lever Locksets	72
Series 180SS Institutional Life Safety Cylindrical Knobsets & Locksets	73
Series 31SS55 Institutional Life Safety Mortise Deadlock	73
Hospital Locksets	74
Series 180PD Cylindrical Push/Pull Paddlesets	74
Series 5PD & 55PD Mortise Push/Pull Paddlesets	74
Mortise Lock Cylinders, Parts & Cams	75
Cylinders, IC Core Cylinder Housings, Cylinder Cams	75
How To Order For Mortise Lock Cylinders	75
KEYS & KEYING	76
HI-SECURITY™ Cylinders	77-82
HI-SECURITY™ Cylinders: NON-UL	77
HI-SECURITY™ Cylinders: UL 437	78
Security-Mate™ Cylinders, Special Application Cylinders	79
How To Order HI-SECURITY™ Cylinders and Keys	80
Keys, Cams & Tailpieces	81
Parts List	82

DOOR CLOSERS & PANIC DEVICES PRICE LIST

Exit Devices	83-87
Series M9900 Exit Device - Rim Mount	83
Series M9900 VR Exit Device - Surface Vertical Rod	83
Series M9900 Exterior Trim	84
Series M9900 Cams & Tailpieces	84
Series M8800 Exit Device	84
Series M195	85
Series M9300 Exit Device - Mortise	85
Electric Latch Retraction with Simultaneous Dogging	86
Exit Alarm	86
Electric Frame Actuator	87
Electric Dogging	87
Delayed Egress	88
M9900 LITE	88
Power Transfer Hinges & Loops	89
Touchless Exit Switch	90
How To Order Door Closers & Panic Devices	91
NEW! ArchiTech™ Series Networx Locks	92-94

Marks USA Antimicrobial finish

Peace of mind for your hardware application when protected against GERMS and MOLD using Stericoat AM. Marks USA antimicrobial finish is recommended for hospitals, assisted living facilities, schools and childcare facilities. **Use Code - AM**

Lifetime Mechanical Limited Warranty: MARKS USA warrants that its products are free from defects in materials and workmanship. This warranty is limited to the lifetime of the door on which our lock is installed. In the event our product does not conform to this warranty, MARKS USA will repair or replace the product free of charge. This warranty does not cover defects or damage arising from improper installation, lack of or improper maintenance, improper storage, shipping and handling, ordinary wear and tear, misuse, abuse, accident, unauthorized service, or use with unauthorized non-MARKS products or parts. We reserve the right to make changes in materials, components or manufacturing methods. Liability under all warranties expressed or implied is limited to replacement of the defective goods. This warranty does not cover nor provide for the reimbursement or payment of incidental or consequential damages. Additionally, the company will not warrant ANSI A156.2 Grade 2 lever product installed in educational facilities and student housing.

2 Year Electronic Limited Warranty: MARKS USA warrants to the original purchaser that its products are free from defects in materials and workmanship so long as they occupy the premises.

In the event our product does not conform to this warranty, MARKS USA will repair or replace the product free of charge at its sole discretion. This warranty does not cover defects or damage arising from improper installation, lack of or improper maintenance, improper storage, shipping and handling, improper application or specification, ordinary wear and tear, misuse, abuse, accident, improper voltage, unauthorized service, or use with unauthorized non-MARKS products or parts. We reserve the right to make changes in materials, components or manufacturing methods. Liability under all warranties expressed or implied is limited to replacement of the defective goods. This warranty does not cover nor provide for the reimbursement or payment of incidental or consequential damages or any shipping charges related to exercising of this warranty.

Lifetime Finish Limited Warranty: MARKS USA Locksets with the "3E" finish will be warranted to the original user against tarnishing as long as the user occupies the residential premises upon which the lockset was originally installed. Locksets with this finish, used in commercial applications will be limited to two years. This warranty does not cover scratches, abrasion, abused or misused products. Upon return of a defective product to Marks USA, we will, at our sole discretion, either replace the product or refund the purchase price in exchange for the product.

Due to climatic conditions, chemical or abrasive actions, other finishes are excluded from this warranty. This warranty does not cover nor provide for the reimbursement or payment of incidental or consequential damages arising from the sale of the product.

Terms & Conditions:

TERMS: Net 30

FREIGHT: Prices are F.O.B. Amityville, New York. Freight allowed on shipments over \$7000 net invoice value within Continental U.S.

RETURNED GOODS: Goods may not be returned without a Returned Goods Authorization (RGA) and are subject to a restocking charge. RGA label must be on all cartons.

MINIMUM CHARGE: Orders for less than \$250 net invoice are subject to a \$25 handling charge.

MINIMUM SALES VOLUME: The company reserves the right to discontinue direct sales to any customer who does not meet the minimum annual sales requirements during any 12 month period. Minimum annual sales volume is determined on the basis of accepted orders during each applicable year. All orders are acknowledged. It is the customers responsibility to check accuracy of the acknowledgment when received.

ArchiTech, Networx, iLock, LocDown, LifeSaver and Hi-Security are trademarks of Marks USA, a division of Napco Security Technologies. All other trademarks listed are properties of their respective companies.

Effective Septemeber 2016. All prices published are suggested list prices in US Dollars. Some specifications are preliminary and subject to change without prior notice. Not responsible for typographical errors. Marks USA is a Division of Napco Security Technologies, Inc. (NASDAQ:NSSC) © Marks USA, 9.16

BACKSET - Required Information

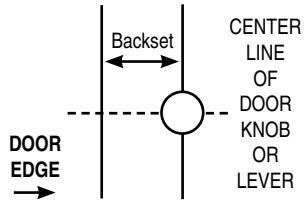

DOOR THICKNESS - Required Information

STANDARD DOOR THICKNESS RANGE:
 Mortise locksets: 1-3/4"
 Cylindrical locksets: 1-5/8" through 1-7/8"
 Ornamental locksets: 1" through 1-1/4"
 Tubular locksets: 1-3/8" through 1-3/4"
 Other door thickness: **Consult factory**

SPECIFY:
 Door thickness (A)
 Lock location (B)

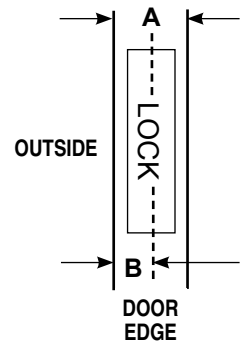

HANDING - Required Information

All locksets supplied 1/2 (LH) and 1/2 (RH) unless otherwise specified

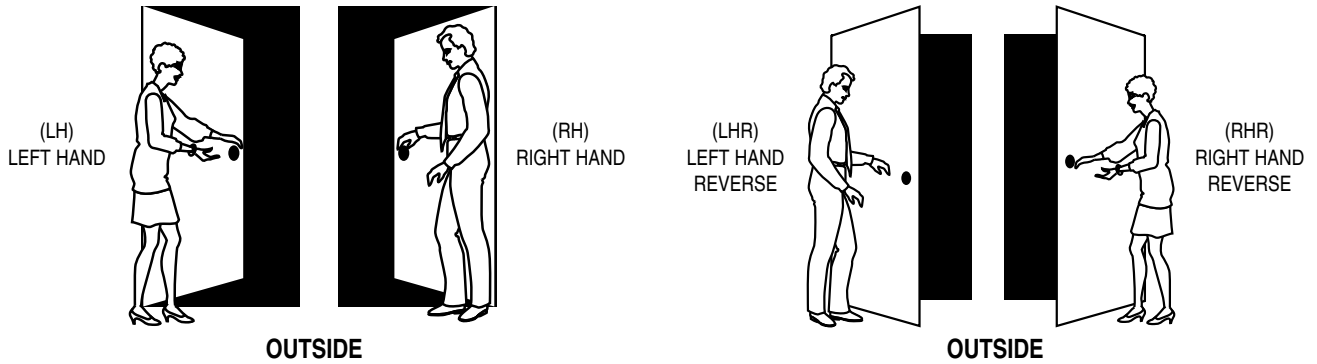

MOUNTS & DISPLAYS AVAILABLE, CONSULT FACTORY

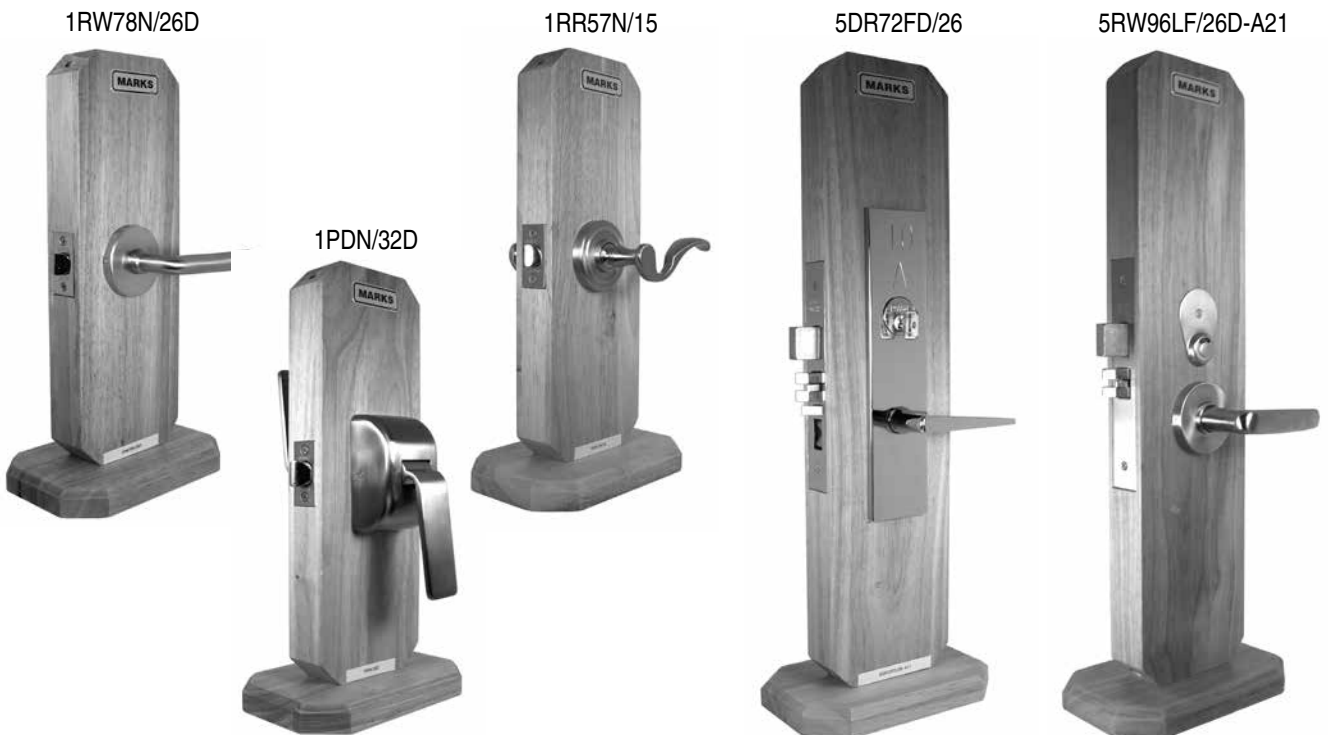

MORTISE LOCK TRIM INFORMATION

HANDLESET TRIM

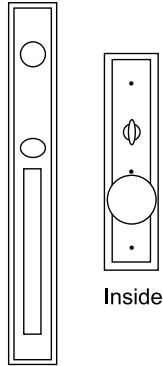

Outside

Inside

**ENTRANCE
Cylinder/Turnpiece**

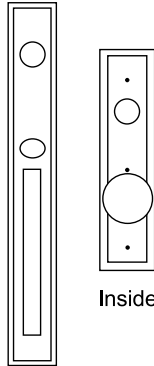

Outside

Inside

**ENTRANCE
Double Cylinder**

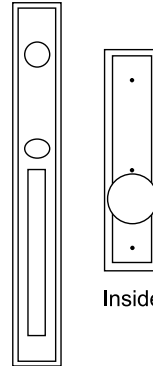

Outside

Inside

**DUMMY TRIM
Both Sides**

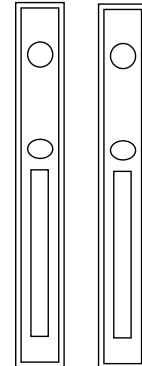

Outside

Inside

**HANDLE SET
With Ext. &
Int. Handle**

LEVERSET/KNOBSET TRIM

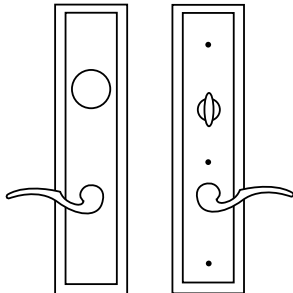

Outside

Inside

**ENTRANCE
Cylinder/Turnpiece**

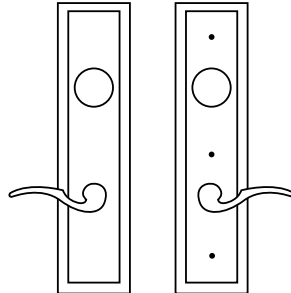

Outside

Inside

**ENTRANCE
Double Cylinder**

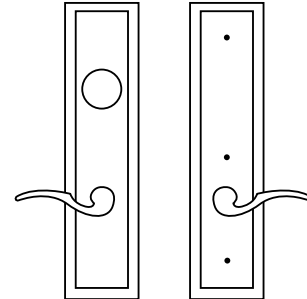

Outside

Inside

OFFICE/CLASSROOM

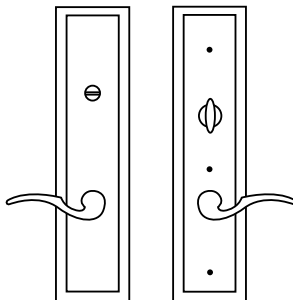

Outside

Inside

PRIVACY

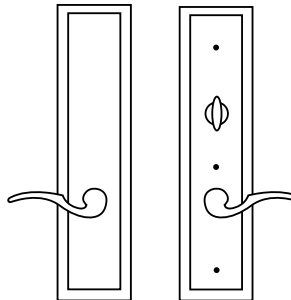

Outside

Inside

EXTERIOR/PATIO

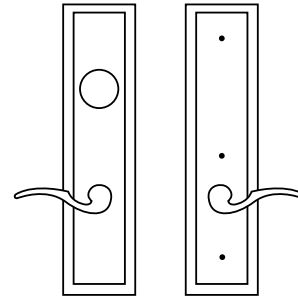

Outside

Inside

**DUMMY TRIM
Both sides**

*Dummy cylinder optional (F17)

How To ORDER MORTISE LOCKSETS & HANDLESETS

1. Select type of lockset.
2. See corresponding pages in the catalogues for information regarding this type of lock.
3. Create the part number for your lock by selecting the information from fields 1 through 6.
Please note dummy trim is Series "0".
4. Options must be listed in Alpha - Numeric order.
5. Note that if Part Number is over 15 characters, it becomes a special number with the option field *1.
(Your options will then be listed separately.)
Please note the standard (default) features of each lock - they do not need to be selected in the options section.
6. Please indicate keying detail or special instructions on each item ordered.
7. Door Templates are available on the website @ www.marksus.com/support/templates

How To Order Example for Mortise Locksets	7	NY	10	A	/	3	—	G3
	1. Lock Series	2. Plate/Rose Design	3. Knob/Lever Design	4. Marks Function	Slash	5. Finish	Dash	6. Options

How To Order Example for Rose Design	5	RW	92	N	/	10B	—	D1
	1. Lock Series	2. Plate/Rose Design	3. Knob/Lever Design	4. Marks Function	Slash	5. Finish	Dash	6. Options

How To Order Example for Handlesets	6	CB	60	AC	/	15	—	G3
	1. Series	2. Handleset Design	3. Interior Knob/Lever Design	4. Marks Function	Slash	5. Finish	Dash	6. Options

How To Order Example for Ornamental Iron	9215	AC	/	15	—	G3
	1. Series	2. Marks Function	Slash	3. Finish	Dash	4. Options

How To Order Example for Mortise Lock Bodies	55	JM	/	26D	—	T
	1. Series	2. Marks Function	Slash	3. Finish	Dash	4. Options

How To ORDER MORTISE LOCKSETS & HANDLESETS

1 SERIES	
Dummy Trim	0
Dummy Trim Handlesets Only	00
Mortise Locks	4, 45, 5, 55, 6, 7, 8, 9
Mortise Deadlocks	31, 2, 3

2 PLATES/ROSES/HANDLESETS		
PLATES		DESIGN
Barrier		BA
Classic		CL
Capitol		CP
Crown		CR
Drake		DR
Davos		DV
Madison		MA
New Yorker		NY
School		LA
Towne		TN
ROSES		DESIGN
9602-R	Rose with ring 2-9/16" dia.	RR
9602	Plain rose 2-9/16" dia.	RW
5602-R	Small rose with ring 2-1/4" dia.	RQ
5602	Small rose 2-1/4" dia.	RS
7602	Square rose 2-9/16"	RX
7607	Square forged rose 2-9/16"	RK
HANDLESETS		DESIGN
Crown		CR
Towne		TN

3 KNOB/LEVER		
KNOB	DESIGN	
1153	Round, wrought	10
1253	Ball, wrought	20
9631	Ball, forged	30
9609	Eclipse, forged	60
LEVERS	DESIGN	
5642	Stanhope	44
5657	Brompton	55
5662	Monaco	57
5672	Towne	72
5677	Maxwell	77
5678	Omni	78
5682	Plaza	82
5683	Dayton	83
5686	Crescent	86
5692	American	92
5696	Titan	96

4 MORTISE FUNCTIONS		
MARKS FUNCTION:		
KEYED SINGLE CYLINDER, NO DEADBOLT		
		ANSI #
D	OFFICE/VEST.	
DW	VESTIBULE	
E	OFFICE	F04
EW	STOREROOM	F07
EX	EXIT	F31
J	CLASSROOM	F05
JM	HOSPITAL	F06
JR	HOSPITAL	F06
GL	INST PRIVACY	F26
EN	STOREROOM	
DN	STOREROOM	
EL	ELECTRICALLY LOCKED	
EU	ELECTRICALLY UNLOCKED	
KEYED SINGLE CYLINDER, WITH DEADBOLT		
		ANSI #
A	ENTRANCE	F08,
F10		
B	ENTRANCE	F21
F	DORMITORY	F12
FS	DORMITORY	
FW	DORMITORY	F13
FD	APARTMENT	F20
H	HOTEL	F15
LH	SPECIAL PRIVACY	
KEYED DOUBLE CYLINDER, NO DEADBOLT		
		ANSI #
G	ENTRANCE	F09
GC	INTRUDER LATCHBOLT	F32
GG	CLASSROOM SECURITY	
GR	CLASSROOM SECURITY w/	
HOLDBACK		
WW	INSTITUTION	F30
KEYED DOUBLE CYLINDER, WITH DEADBOLT		
		ANSI #
AC	ENTRANCE	F35
C	STOREROOM	F14
FC	INTRUDER DEADBOLT	F34
FA	DORMITORY	F11
FX	DORMITORY	F33
SO	STOREROOM	F25
KEYLESS		
		ANSI #
N	PASSAGE	F01
L	BATHROOM	F02
LF	PRIVACY	F19
LJ	PRIVACY	F22
DUMMY TRIM		
		ANSI #
DI	DUMMY TRIM INSIDE	
DO	DUMMY TRIM OUTSIDE	
DT	FULL DUMMY TRIM	



5 FINISH		
MARKS		ANSI #
US 3	Polished Brass, Clear Coated	605
US 3E	Polished Brass "PVD"	605E
US 4	Satin Brass, Clear Coated	606, 606E
US 5	Antique Brass, Clear Coated	609, 609E
US 10E	Satin Bronze "PVD"	612E
US 10	Satin Bronze, Clear Coated	612
US 10B	Dark Bronze, Clear Coated	613E
US 14	Bright Nickel Plating, Clear Coated	614
US 15	Satin Nickel	619, 619E
US 19	Flat Black, Powder Coated	622, 622E
US 20A	Dark Oxidized Statuary Bronze, Clear Coated	624
US 26	Polished Chrome, Plated	625
US 26D	Satin Chrome, Plated	626
US 26E	Satin Chrome, Powder Coat	626E
US 32	Polished Stainless Steel	629
US 32D	Satin Stainless Steel	630
AM	Antimicrobial Finish	AM, +40



FINISH DESIGNATIONS	
Split Finish Designation	
Marks USA Antimicrobial finish - Code: AM	
Split Finish: Exterior one finish/interior one finish designate by an "X"	
Ex: 4TN57A/3Ex15-F3	
Exterior trim 3E Interior Trim US 15	
Combination Finish Designation	
Combination Finish:	
Alternating different finishes on same side of trim designate by a "/" between finishes	
Ex: 4TN57A/3E/15-F3	
Exterior and Interior trim 3E	
US 15 cylinder, turnpiece & lever.	





How To ORDER MORTISE LOCKSETS & HANDLESETS

6			OPTIONS										
LOCK FRONT			CODE	PRICE	DOOR THICKNESS		CODE	PRICE	ELECTRIFIED		CODE	PRICE	
1-1/16" x 8"	Q	27			50 mm (2")	D1	NC		24V	H1			
1-1/16" x 5-5/8"	R	28			57 mm (2-1/4")	D2	44		12V	H2			
1-1/16" x 7-5/8"	T	27			60 mm (2-3/8")	D3	44		Electrically locked	H9			
1-1/4" x 10"	U	109			1-3/4"	D4	NC		Electrically unlocked	H10			
1" x 7-3/4"	V	27			1-3/8"	D5	NC		STRIKE				
1" x 7-1/8"	W	NC			1" - 1-1/4"	D6	NC			CODE	PRICE		
1-1/4" x 8"	X	25			2" - 2-1/4"	D7	44		4-7/8" ASA strike	S1	13		
1-1/4" x 8-5/8"	Y	109			1-1/4" - 1-1/2"	D8	NC		Straight lip strike	S2	3		
1" x 8"	Z	25			Over 3"	D9	648		2-3/4" "T" strike	S3	NC		
TRIM MODIFICATIONS			CODE	PRICE					3-5/8" x 1-1/4" Security strike	S4	11		
Tactile knob/lever, coated ext. only	A1	60			63.5 mm (2-1/2")	D10	71		2-1/4" Curved lip strike	S5	NC		
Emergency coinkey	A2	28			75 mm (3")	D11	90		4-7/8" Strikes: 1 Left / 1 Right	S6	13		
Tamper-proof screws	A3	14			72 mm (2-13/16")	D12	90		Strike with 1-1/2" lip	S7	16		
Tactile knob/lever, knurled	A4	60			2-3/4"-3"	D14	300		Radius corner strike	S8	NC		
Handicapped turnpiece	A5	18			LATCH		CODE	PRICE	4035-1 strike	S9	NC		
Hotel indicator	A6	44			Solid latch	E1	20		TURNPIECES			CODE	PRICE
Pinned knob	A7	35			Hold open latch	E2	37		TP 1	T1	+ 17		
Large rose 3-1/8" diameter	A8	11			Auxiliary latch	E3	35		TP 3	T3	+ 17		
Mushroom knob	A9	5			2-3/4" backset, 1-1/8" x 2-1/4" face	E4	10		TP 4	T4	+ 17		
No logo	A10	NC			2-3/8" backset, 1" x 2-1/4" face	E6	NC		TP 5	T5	+ 17		
Engraved	A11	71			TRIM CHANGES		CODE	PRICE	TP 6	T6	+ 17		
Concealed cylinder	A12	27			Lead lined	F1	325		TP 7	T7	+ 17		
Dummy trim sub-assembly	A13	—			Large inside plate	F2	35		TP 9	T9	+ 17		
Coinkey w/ escutcheon plate	A14	71			Less inside trim**	F4	NC		TP 16	T16	+ 17		
Coinkey w/ rose	A15	71			Less outside trim**	F5	NC		ELECTRONICS			CODE	PRICE
Occupancy Indicator	A17	90			For 1-1/2" bore	F6	20		Sensor array package: REX & key switch	W1	320		
Tactile knob/lever, coated int. & ext.	A18	122			Adjustable spring collars	F10	5		Hard wired	W5	26		
BE 1-1/2" thick door adapter plate	A19	78			Corbin 6 pin IC core	F12	32		Request to exit switch	W10	160		
Rigid Lever	A20	NC			Corbin 7 pin IC core	F13	34		Key sensor	W11	160		
"Tear Drop" occupancy indicator	A21	79			Yale 6 pin IC core	F14	23		Titan lever	W12	19		
Crescent Lever	A22	NC			Yale 7 pin IC core	F15	23		Request to EXit switch, key sensor				
Square trim	A23	29			Less outside knob/lever	F16			& bolt sensor	W13	480		
- Square collar	A23C	+10			Dummy cylinder	F17	44		<i>(W13 option for mortise locksets)</i>				
- Square turnpiece	A23T	+10			Less outside trim w/ custom escutcheon**		F18	NC	Bolt sensor	W14	160		
Small emergency hole	A24	NC			Schlage 6 pin IC core	F19	23		Latch sensor	W15	160		
SS55 Knob on EXT or INT (specify)	A25	43			Sargent IC core	F20	23		REX + Latch sensor	W16	320		
Plaza Lever	A26	NC			Medeco IC core large format	F21	23		MISC			CODE	PRICE
Recessed Pull (one side)	A28	71			IQ lead lined	F22	416		Please read special comments	#			
Exposed Rose Screws	A29	NC			Rigid Lever	F23	NC		regarding line item.				
Engraved and Filled	A30	81			ASSA IC Core	F24	21		* Not available in CP plate design.				
Inside Knob on Lever	A31	35			Blank Inside Plate/Lever	F25	NC		** Consult factory before ordering.				
No inside turnpiece	A32	NC			Blank Outside Plate/Lever	F26	NC						
LOCK BODY <i>Red, Green, BCC, Ind.</i>			CODE	PRICE	Yale 6 pin IC core w/ captivated tail	F27	NC						
Lever override guard - outside*	B1	44			Yale 7 pin IC core w/ captivated tail	F28	NC						
Lever override guard - both sides*	B2	62			Screwless Inside Escutcheon	F29	30						
Hardened pins - deadbolt	B3	18			CYLINDER		CODE	PRICE					
Lever springs	B4	19			IC core housing - 7 Pin	G1	NC						
Pin and lever springs	B5	37			Special optional keyway	G2	37						
Hollow spacer	B6	18			Less cylinder	G3	Deduct 15						
8 mm hubs on square	B7	18			MARKS "A" keyway	G4	14						
Turnpiece hub on square	B8	11			MARKS "C" keyway	G5	16						
With deadbolt	B9	18			IC core housing w/9271 Collar - 6 Pin	G6	NC						
Boxed Lock Body	B10	NC			IC core housing, Schlage large format								
Lever spring outside only	B11	NC			(FOR MORTISE ONLY)	G7	80						
Lever spring inside only	B12	NC											



BARRIER PLATE DESIGN BA

	ANSI-A156.13 • Grade 1 3 Hour Fire Rating		Series 5 • 2-3/4" Backset Series 55 • 2-1/2" Backset	
	Standard Features		KNOBS	LEVERS
	<ul style="list-style-type: none"> • Thru-bolted screwless knob/lever plate assemblies • Independent spring loaded captivated spindles • Reversible mortise lock 2-1/2" or 2-3/4" backset • Lever support springs • Lock front: 1-1/4" x 8" • Dimensions: Ext: 10-1/8" H x 4" W, Int: 10-3/4" H x 4" W • Cylinder: MARKS "C" keyway, 6 pin w/ 2 keys 		10, 20	82, 83, 86, 92, 96
			FINISH GROUPS	
MARKS #	FUNCTION	ANSI #	32D	32D
KEYED SINGLE CYLINDER, NO DEADBOLT				
D	OFFICE VEST.		566	605
DW	VESTIBULE			
E	OFFICE	F04		
EW	STOREROOM	F07		
J	CLASSROOM	F05		
JM, JR	HOSPITAL	F06		
GL	INSTIT. PRIVACY	F26		
EL	ELECTRICALLY LOCKED		932	972
EU	ELECTRICALLY UNLOCKED			
KEYED SINGLE CYLINDER, WITH DEADBOLT				
A	ENTRANCE	F08, F10	584	619
B	ENTRANCE	F21		
F	DORMITORY	F12		
FS	DORMITORY			
FW	DORMITORY	F13		
FD	APARTMENT	F20	609	648
H	HOTEL	F15		
LH	SPECIAL PRIVACY			
KEYED DOUBLE CYLINDER, NO DEADBOLT				
G	APARTMENT	F09	618	658
GC	INTRUDER LATCHBOLT	F32		
GG	CLASSROOM SECURITY			
GR	CLASSROOM SECURITY w/HOLDBACK			
WW	INSTITUTIONAL	F30		
KEYED DOUBLE CYLINDER, WITH DEADBOLT				
AC	ENTRANCE	F35	620	658
C	STOREROOM	F14		
FC	INTRUDER DEADBOLT	F34		
FA	DORMITORY	F11		
FX	DORMITORY	F33		
KEYLESS				
N	PASSAGE	F01	453	492
L	BATHROOM	F02	584	619
LF	PRIVACY	F19		
LJ	PRIVACY	F22	514	551
EX	EXIT	F31		
DUMMY TRIM				
DI	DUMMY TRIM INSIDE		230	267
DO	DUMMY TRIM OUTSIDE			
DT	FULLY DUMMY		460	497
KNOB & LEVERS ARE PACKED 6 PER CASE				
NOTE: Split designs and/or finishes are priced at the highest design and/or finish • Special finishes, consult factory				

KNOB	Round Knob 10	
	Ball Knob 20	

LEVER	Plaza Lever 82 Specify handing	
	Dayton Lever 83 Specify handing	
	Crescent Lever 86	
	American Lever 92	
	Titan Lever 96	

CLASSIC PLATE DESIGN CL

	ANSI-A156.13 • Grade 1 3 Hour Fire Rating		Series 5 • 2-3/4" Backset Series 55 • 2-1/2" Backset				
	Standard Features		KNOBS		LEVERS		
	<ul style="list-style-type: none"> • Thru-bolted screwless knob/lever plate assemblies • Independent spring loaded captivated spindles • Reversible mortise lock 2-1/2" or 2-3/4" backset • Lever support springs • Lock front: 1-1/4" x 8" • Dimensions: Ext: 8" H x 2-1/2" W, Int: 8" H x 2-1/2" W • Cylinder: MARKS "C" keyway, 6 pin w/ 2 keys • Height: 7/32" 		10, 20		031, 44, 55, 57, 72, 77, 78, 82, 83, 86, 92, 96		031, 82, 83, 86, 92, 96
FINISH GROUPS							
MARKS #	FUNCTION	ANSI #	3, 26D, 32D	10, 10B	3E, 10, 26D, 32D	10B, 32	
KEYED SINGLE CYLINDER, NO DEADBOLT							
D	OFFICE VEST.		613	650	756	793	
DW	VESTIBULE						
E	OFFICE	F04					
EW	STOREROOM	F07					
J	CLASSROOM	F05					
JM, JR	HOSPITAL	F06					
GL	INSTIT. PRIVACY	F26					
EL	ELECTRICALLY LOCKED		929	966	1072	1109	
EU	ELECTRICALLY UNLOCKED						
KEYED SINGLE CYLINDER, WITH DEADBOLT							
A	ENTRANCE	F08, F10	626	664	770	807	
B	ENTRANCE	F21					
F	DORMITORY	F12					
FS	DORMITORY						
FW	DORMITORY	F13					
FD	APARTMENT	F20	688	725	831	868	
H	HOTEL	F15					
LH	SPECIAL PRIVACY						
KEYED DOUBLE CYLINDER, NO DEADBOLT							
G	APARTMENT	F09	660	697	803	841	
GC	INTRUDER LATCHBOLT	F32					
GG	CLASSROOM SECURITY						
GR	CLASSROOM SECURITY w/HOLDBACK						
WW	INSTITUTIONAL	F30					
KEYED DOUBLE CYLINDER, WITH DEADBOLT							
AC	ENTRANCE	F35	660	697	803	841	
C	STOREROOM	F14					
FC	INTRUDER DEADBOLT	F34					
FA	DORMITORY	F11					
FX	DORMITORY	F33					
KEYLESS							
N	PASSAGE	F01	515	552	658	695	
L	BATHROOM	F02	628	665	771	808	
LF	PRIVACY	F19					
LJ	PRIVACY	F22	567	604	710	747	
EX	EXIT	F31	567	604	710	747	
DUMMY TRIM							
DI	DUMMY TRIM INSIDE		258	277	330	348	
DO	DUMMY TRIM OUTSIDE						
DT	FULLY DUMMY		516	553	659	690	

KNOBS & LEVERS ARE PACKED 6 PER CASE



NOTE: Split designs and/or finishes are priced at the highest design and/or finish • Special finishes, consult factory

CLASSIC PLATE DESIGN CL

	ANSI-A156.13 • Grade 2		Series 7 • 2-3/4" Backset Series 9 • 2-1/2" Backset			
	Standard Features		KNOBS		LEVERS	
	<ul style="list-style-type: none"> • Thru-bolted screwless knob/lever plate assemblies • Independent spring loaded captivated spindles • Reversible mortise lock 2-1/2" or 2-3/4" backset • Lever support springs • Lock front Series 7: 1-1/4" x 8", Series 9: 1-1/16" x 7-5/8" • Dimensions: Ext: 8" H x 2-1/2" W, Int: 8" H x 2-1/2" W • Cylinder: MARKS "C" keyway, 6 pin w/ 2 keys 		10, 20		031, 44, 55, 57, 72, 77, 78, 82, 83, 86, 92, 96	
FINISH GROUPS						
MARKS #	FUNCTION	ANSI #	3, 26D, 32D	10, 10B	3E, 10, 26D, 32D	10B, 32
KEYED SINGLE CYLINDER, NO DEADBOLT						
D	OFFICE VEST.		581	618	724	761
DW	VESTIBULE					
KEYED SINGLE CYLINDER, WITH DEADBOLT						
A	ENTRANCE	F08, F10	595	629	738	775
B	ENTRANCE	F21				
F	DORMITORY	F12				
FS	DORMITORY					
FW	DORMITORY	F13				
KEYED DOUBLE CYLINDER, WITH DEADBOLT						
AC	ENTRANCE	F35	629	666	772	809
C	STOREROOM	F14				
FX	DORMITORY	F33				
KEYLESS						
N	PASSAGE	F01	483	520	626	664
L	BATHROOM	F02	596	633	739	776
LF	PRIVACY	F19				
DUMMY TRIM						
DI	DUMMY TRIM INSIDE		259	277	330	349
DO	DUMMY TRIM OUTSIDE					
DT	FULLY DUMMY		516	553	659	696
NOTE: Split designs and/or finishes are priced at the highest design and/or finish • Special finishes, consult factory						



KNOBS	Round Knob 10	Ball Knob 20				
						
LEVERS	Stanhope Lever 44	Copa Lever 031	Brompton Lever 55	Monaco Lever 57 Specify handing		
						
	Towne Lever 72	Maxwell Lever 77	Omni Lever 78	Plaza Lever 82 Specify handing		
						
	Dayton Lever 83 Specify handing	Crescent Lever 86	American Lever 92	Titan Lever 96		
						

CAPITOL PLATE DESIGN CP

		ANSI-A156.13 • Grade 1 3 Hour Fire Rating				
		Standard Features	KNOBS		LEVERS	
		<ul style="list-style-type: none"> • Thru-bolted screwless knob/lever plate assemblies • Independent spring loaded captivated spindles • Reversible mortise lock 2-1/2" or 2-3/4" backset • Lever support springs • Lock front: 1-1/4" x 8" • Dimensions: Ext: 8-1/2" H x 2-3/4" W, Int: 8-1/2" H x 2-3/4" W • Cylinder: MARKS "C" keyway, 6 pin w/ 2 keys • Concealed 5 pin cylinder (option A12) • Thickness: 1/8" 	10, 20		031, 44, 55, 57, 72, 77, 78, 82, 83, 86, 92, 96	031, 82, 83, 86, 92, 96
FINISH GROUPS						
MARKS #	FUNCTION	ANSI #	3, 32D	10, 10B	3, 32D	10, 10B
KEYED SINGLE CYLINDER, NO DEADBOLT						
D	OFFICE VEST.		638	675	781	818
DW	VESTIBULE					
E	OFFICE	F04				
EW	STOREROOM	F07				
J	CLASSROOM	F05				
JM, JR	HOSPITAL	F06				
GL	INSTIT. PRIVACY	F26				
EL	ELECTRICALLY LOCKED		954	991	1097	1134
EU	ELECTRICALLY UNLOCKED					
KEYED SINGLE CYLINDER, WITH DEADBOLT						
A	ENTRANCE	F08, F10	651	689	795	832
B	ENTRANCE	F21				
F	DORMITORY	F12				
FS	DORMITORY					
FW	DORMITORY	F13				
FD	APARTMENT	F20	713	750	856	894
H	HOTEL	F15				
LH	SPECIAL PRIVACY					
KEYED DOUBLE CYLINDER, NO DEADBOLT						
G	APARTMENT	F09	686	723	829	866
GC	INTRUDER LATCHBOLT	F32				
GG	CLASSROOM SECURITY					
GR	CLASSROOM SECURITY w/HOLDBACK					
WW	INSTITUTIONAL	F30				
KEYED DOUBLE CYLINDER, WITH DEADBOLT						
AC	ENTRANCE	F35	686	723	829	866
C	STOREROOM	F14				
FC	INTRUDER DEADBOLT	F34				
FA	DORMITORY	F11				
FX	DORMITORY	F33				
KEYLESS						
N	PASSAGE	F01	541	578	684	721
L	BATHROOM	F02	653	690	796	833
LF	PRIVACY	F19				
LJ	PRIVACY	F22	593	630	736	773
EX	EXIT	F31	593	630	736	773
DUMMY TRIM						
DI	DUMMY TRIM INSIDE		271	289	342	361
DO	DUMMY TRIM OUTSIDE					
DT	FULLY DUMMY		541	579	685	722
KNOB & LEVERS ARE PACKED 6 PER CASE						
NOTE: Split designs and/or finishes are priced at the highest design and/or finish • Special finishes, consult factory						



CAPITOL PLATE DESIGN CP

	ANSI-A156.13 • Grade 2		Series 7 • 2-3/4" Backset Series 9 • 2-1/2" Backset				
	Standard Features		KNOBS		LEVERS		
	<ul style="list-style-type: none"> • Thru-bolted screwless knob/lever plate assemblies • Independent spring loaded captivated spindles • Reversible mortise lock 2-1/2" or 2-3/4" backset • Lever support springs • Lock front Series 7: 1-1/4" x 8", Series 9: 1-1/16" x 7-5/8" • Dimensions: Ext: 8-1/2" H x 2-3/4" W, Int: 8-1/2" H x 2-3/4" W • Cylinder: MARKS "C" keyway, 6 pin w/ 2 keys • Concealed 5 pin cylinder (option A12) 		10, 20		031, 44, 55, 57, 72, 77, 78, 82, 83, 86, 92, 96		
				FINISH GROUPS			
MARKS #	FUNCTION	ANSI #	3, 32D	10,10B	3, 32D	10, 10B	
KEYED SINGLE CYLINDER, NO DEADBOLT							
D	OFFICE VEST.		606	643	749	787	
DW	VESTIBULE						
KEYED SINGLE CYLINDER, WITH DEADBOLT							
A	ENTRANCE	F08, F10	620	657	763	800	
B	ENTRANCE	F21					
F	DORMITORY	F12					
FS	DORMITORY						
FW	DORMITORY	F13					
KEYED DOUBLE CYLINDER, WITH DEADBOLT							
AC	ENTRANCE	F35	654	691	797	834	
C	STOREROOM	F14					
FX	DORMITORY	F33					
KEYLESS							
N	PASSAGE	F01	509	546	652	689	
L	BATHROOM	F02	621	658	764	801	
LF	PRIVACY	F19					
DUMMY TRIM							
DI	DUMMY TRIM INSIDE		270	289	342	361	
DO	DUMMY TRIM OUTSIDE						
DT	FULLY DUMMY		542	579	685	722	
NOTE: Split designs and/or finishes are priced at the highest design and/or finish • Special finishes, consult factory							

KNOBS	Round Knob 10	Ball Knob 20	
			

LEVERS	Stanhope Lever 44	Copa Lever 031	Brompton Lever 55	Monaco Lever 57 Specify handing
				
	Towne Lever 72	Maxwell Lever 77	Omni Lever 78	Plaza Lever 82 Specify handing
				
	Dayton Lever 83 Specify handing	Crescent Lever 86	American Lever 92	Titan Lever 96
				

CROWN PLATE DESIGN CR

		ANSI-A156.13 • Grade 1 3 Hour Fire Rating			Series 5 • 2-3/4" Backset Series 55 • 2-1/2" Backset						
	Standard Features		KNOBS			LEVERS					
	<ul style="list-style-type: none"> • Thru-bolted screwless knob/lever plate assemblies • Independent spring loaded captivated spindles • Reversible mortise lock 2-1/2" or 2-3/4" backset • Lever support springs • Lock front: 1-1/4" x 8" • Dimensions: Ext: 8-1/2" H x 2" W, Int: 8-1/2" H x 2" W • Cylinder: MARKS "C" keyway, 6 pin w/ 2 keys • Concealed 5 pin cylinder (option A12) • Height: 13/32" • Square Edges 		10, 20			30, 60			031, 44, 55, 57, 72, 77, 78, 82, 83, 86, 92, 96		031, 82, 83, 86, 92, 96
FINISH GROUPS											
MARKS #	FUNCTION	ANSI #	3, 26D, 32D	10, 10B, 32	3E, 15, 26D	10, 10B, 14	3E, 15, 26D	10, 10B, 14, 19E, 26	32, 32D		
KEYED SINGLE CYLINDER, NO DEADBOLT											
D	OFFICE VEST.		659	696	700	737	759	833	796		
DW	VESTIBULE										
E	OFFICE	F04									
EW	STOREROOM	F07									
J	CLASSROOM	F05									
JM, JR	HOSPITAL	F06									
GL	INSTIT. PRIVACY	F26									
EL	ELECTRICALLY LOCKED		975	1012	1015	1038	1060	1134	1097		
EU	ELECTRICALLY UNLOCKED										
KEYED SINGLE CYLINDER, WITH DEADBOLT											
A	ENTRANCE	F08, F10	673	710	713	750	773	847	810		
B	ENTRANCE	F21									
F	DORMITORY	F12									
FS	DORMITORY										
FW	DORMITORY	F13									
FD	APARTMENT	F20	694	731	735	772	794	868	831		
H	HOTEL	F15									
LH	SPECIAL PRIVACY										
KEYED DOUBLE CYLINDER, NO DEADBOLT											
G	APARTMENT	F09	703	740	743	780	802	877	840		
GC	INTRUDER LATCHBOLT	F32									
GG	CLASSROOM SECURITY										
GR	CLASSROOM SECURITY w/HOLDBACK										
WW	INSTITUTIONAL	F30									
KEYED DOUBLE CYLINDER, WITH DEADBOLT											
AC	ENTRANCE	F35	703	740	743	780	802	877	840		
C	STOREROOM	F14									
FC	INTRUDER DEADBOLT	F34									
FA	DORMITORY	F11									
FX	DORMITORY	F33									
KEYLESS											
N	PASSAGE	F01	566	603	607	643	666	740	703		
L	BATHROOM	F02	673	710	713	750	773	847	810		
LF	PRIVACY	F19									
LJ	PRIVACY	F22	616	653	656	693	716	790	753		
EX	EXIT	F31									
DUMMY TRIM											
DI	DUMMY TRIM INSIDE		283	304	306	324	336	391	354		
DO	DUMMY TRIM OUTSIDE										
DT	FULLY DUMMY		571	608	612	649	671	745	708		

KNOBS & LEVERS ARE PACKED 6 PER CASE



NOTE: Split designs and/or finishes are priced at the highest design and/or finish • Special finishes, consult factory

CROWN PLATE DESIGN CR

	ANSI-A156.13 • Grade 2		Series 7 • 2-3/4" Backset Series 9 • 2-1/2" Backset												
	Standard Features		KNOBS				LEVERS								
	<ul style="list-style-type: none"> • Thru-bolted screwless knob/lever plate • Independent spring loaded captivated spindles • Reversible mortise lock 2-1/2" or 2-3/4" backset • Lever support springs • Lock front Series 7: 1-1/4" x 8", Series 9: 1-1/16" x 7-5/8" • Dimensions: Ext: 8-1/2" H x 2" W, Int: 8-1/2" H x 2" W • Cylinder: MARKS "C" keyway, 6 pin w/ 2 keys • Concealed 5 pin cylinder (option A12) 		10, 20		30, 60		031, 44, 55, 57, 72, 77, 78, 82, 83, 86, 92, 96		031, 82, 83, 86, 92, 96						
MARKS #			FUNCTION		ANSI #		FINISH GROUPS								
							3, 26D, 32D	10, 10B, 32	3E, 15, 26D	10, 10B, 14	3E, 15, 26D	10, 10B, 14, 19E, 26	32, 32D		
KEYED SINGLE CYLINDER, NO DEADBOLT															
D	OFFICE VEST.		628	665	668	705	727	801	764						
DW	VESTIBULE														
KEYED SINGLE CYLINDER, WITH DEADBOLT															
A	ENTRANCE	F08, F10													
B	ENTRANCE	F21													
F	DORMITORY	F12	641	678	682	718	741	815	778						
FS	DORMITORY														
KEYED DOUBLE CYLINDER, WITH DEADBOLT															
AC	ENTRANCE	F35													
C	STOREROOM	F14													
FX	DORMITORY	F33	671	708	711	748	771	845	808						
KEYLESS															
N	PASSAGE	F01	534	571	575	612	634	708	671						
L	BATHROOM	F02													
LF	PRIVACY	F19	641	678	682	719	741	815	778						
DUMMY TRIM															
DI	DUMMY TRIM INSIDE		286	304	306	324	336	391	354						
DO	DUMMY TRIM OUTSIDE														
DT	FULLY DUMMY		571	598	612	649	671	745	708						
NOTE: Split designs and/or finishes are priced at the highest design and/or finish • Special finishes, consult factory															

KNOBS	Round Knob 10	Ball Knob 20	Ball Knob 30	Eclipse Knob 60
				
LEVERS	Stanhope Lever 44	Copa Lever 031	Brompton Lever 55	Monaco Lever 57 Specify handing
				
	Towne Lever 72	Maxwell Lever 77	Omni Lever 78	Plaza Lever 82 Specify handing
				
	Dayton Lever 83 Specify handing	Crescent Lever 86	American Lever 92	Titan Lever 96
				

DRAKE PLATE DESIGN DR

		ANSI-A156.13 • Grade 1 3 Hour Fire Rating								Series 5 • 2-3/4" Backset Series 55 • 2-1/2" Backset
	Standard Features		KNOBS				LEVERS			
	<ul style="list-style-type: none"> • Thru-bolted screwless knob/lever plate • Independent spring loaded captivated spindles • Reversible mortise lock 2-1/2" or 2-3/4" backset • Lever support springs • Lock front: 1-1/4" x 8" • Dimensions: Ext: 11" H x 2-1/2" W, Int: 11" H x 2-1/2" W • Cylinder: MARKS "C" keyway, 6 pin w/ 2 keys • Concealed 5 pin cylinder (option A12) • Height: 13/32" • Square Edges 		10, 20		30, 60		031, 44, 55, 57, 72, 77, 78, 82, 83, 86, 92, 96		031, 82, 83, 86, 92, 96	
			FINISH GROUPS							
MARKS #	FUNCTION	ANSI #	3, 26D, 32D	10, 10B, 32	3E, 15, 26D	10, 10B, 14	3E, 15, 26D	10E, 10B, 14, 19E, 26	32, 32D	
KEYED SINGLE CYLINDER, NO DEADBOLT										
D	OFFICE VEST.									
DW	VESTIBULE									
E	OFFICE	F04								
EW	STOREROOM	F07	728	765	769	806	828	902	865	
J	CLASSROOM	F05								
JM, JR	HOSPITAL	F06								
GL	INSTIT. PRIVACY	F26								
EL	ELECTRICALLY LOCKED		1044	1081	1084	1106	1129	1203	1166	
EU	ELECTRICALLY UNLOCKED									
KEYED SINGLE CYLINDER, WITH DEADBOLT										
A	ENTRANCE	F08, F10								
B	ENTRANCE	F21								
F	DORMITORY	F12	742	779	782	819	842	916	879	
FS	DORMITORY									
FW	DORMITORY	F13								
FD	APARTMENT	F20								
H	HOTEL	F15	763	800	803	841	862	937	900	
LH	SPECIAL PRIVACY									
KEYED DOUBLE CYLINDER, NO DEADBOLT										
G	APARTMENT	F09								
GC	INTRUDER LATCHBOLT	F32								
GG	CLASSROOM SECURITY		772	809	812	849	871	946	908	
GR	CLASSROOM SECURITY w/HOLDBACK									
WW	INSTITUTIONAL	F30								
KEYED DOUBLE CYLINDER, WITH DEADBOLT										
AC	ENTRANCE	F35								
C	STOREROOM	F14								
FC	INTRUDER DEADBOLT	F34	772	809	812	849	871	946	908	
FA	DORMITORY	F11								
FX	DORMITORY	F33								
KEYLESS										
N	PASSAGE	F01	635	672	675	712	735	809	772	
L	BATHROOM	F02								
LF	PRIVACY	F19	742	779	782	819	842	916	879	
LJ	PRIVACY	F22								
EX	EXIT	F31	685	722	725	762	784	859	822	
DUMMY TRIM										
DI	DUMMY TRIM INSIDE		320	339	340	359	370	426	389	
DO	DUMMY TRIM OUTSIDE									
DT	FULLY DUMMY		640	677	680	718	740	814	777	

KNOBS & LEVERS ARE PACKED 6 PER CASE



NOTE: Split designs and/or finishes are priced at the highest design and/or finish • Special finishes, consult factory

DRAKE PLATE DESIGN DR

	ANSI-A156.13 • Grade 2		Series 7 • 2-3/4" Backset Series 9 • 2-1/2" Backset						
	Standard Features		KNOBBS				LEVERS		
	<ul style="list-style-type: none"> • Thru-bolted screwless knob/lever plate • Independent spring loaded captivated spindles • Reversible mortise lock 2-1/2" or 2-3/4" backset • Lever support springs • Lock front Series 7: 1-1/4" x 8", Series 9: 1-1/16" x 7-5/8" • Dimensions: Ext: 11" H x 2-1/2" W, Int: 11" H x 2-1/2" W • Cylinder: MARKS "C" keyway, 6 pin w/ 2 keys • Concealed 5 pin cylinder (option A12) 		10, 20		30, 60		031, 44, 55, 57, 72, 77, 78, 82, 83, 86, 92, 96		031, 82, 83, 86, 92, 96
FINISH GROUPS									
MARKS #	FUNCTION	ANSI #	3, 26D, 32D	10, 10B, 32	3E, 15, 26D	10, 10B, 14	3E, 15, 26D	10E, 10B, 14, 19E, 26, 32	32D
KEYED SINGLE CYLINDER, NO DEADBOLT									
D	OFFICE VEST.		696	734	737	774	796	870	833
DW	VESTIBULE								
KEYED SINGLE CYLINDER, WITH DEADBOLT									
A	ENTRANCE	F08, F10							
B	ENTRANCE	F21	710	747	750	788	810	884	847
F	DORMITORY	F12							
FS	DORMITORY								
KEYED DOUBLE CYLINDER, WITH DEADBOLT									
AC	ENTRANCE	F35							
C	STOREROOM	F14	740	777	780	817	840	914	877
FX	DORMITORY	F33							
KEYLESS									
N	PASSAGE	F01	603	640	643	681	703	777	740
L	BATHROOM	F02	710	747	750	788	810	884	847
LF	PRIVACY	F19							
DUMMY TRIM									
DI	DUMMY TRIM INSIDE		320	339	340	359	370	426	389
DO	DUMMY TRIM OUTSIDE								
DT	FULLY DUMMY		640	667	681	718	740	814	777
NOTE: Split designs and/or finishes are priced at the highest design and/or finish • Special finishes, consult factory									

KNOBBS	Round Knob 10	Ball Knob 20	Ball Knob 30	Eclipse Knob 60
				
	Stanhope Lever 44	Copa Lever 031	Brompton Lever 55	Monaco Lever 57 Specify handing
				
LEVERS	Towne Lever 72	Maxwell Lever 77	Omni Lever 78	Plaza Lever 82 Specify handing
				
	Dayton Lever 83 Specify handing	Crescent Lever 86	American Lever 92	Titan Lever 96
				

DAVOS PLATE DESIGN DV

BHMA CERTIFIED		ANSI-A156.13 • Grade 1 3 Hour Fire Rating			Series 5 • 2-3/4" Backset Series 55 • 2-1/2" Backset				
	Standard Features		KNOBS			LEVERS			
	<ul style="list-style-type: none"> • Thru-bolted screwless knob/lever plate • Independent spring loaded captivated spindles • Reversible mortise lock 2-1/2" or 2-3/4" backset • Lever support springs • Lock front: 1-1/4" x 8" • Dimensions: Ext: 11" H x 2-1/2" W, Int: 11" H x 2-1/2" W • Cylinder: MARKS "C" keyway, 6 pin w/ 2 keys • Concealed 5 pin cylinder (option A12) • Height: 13/32" • Bevel Edges 		10, 20	30, 60	031, 44, 55, 57, 72, 77, 78, 82, 83, 86, 92, 96				
		FINISH GROUPS							
MARKS #	FUNCTION	ANSI #	3, 26D, 32D	10, 10B, 32	3E, 15, 26D	10, 10B, 14	3E, 15, 26D	10E, 10B, 14, 19E, 26	
KEYED SINGLE CYLINDER, NO DEADBOLT									
D	OFFICE VEST.								
DW	VESTIBULE								
E	OFFICE	F04							
EW	STOREROOM	F07	798	835	838	876	898	972	
J	CLASSROOM	F05							
JM, JR	HOSPITAL	F06							
GL	INSTIT. PRIVACY	F26							
EL	ELECTRICALLY LOCKED		1114	1151	1154	1177	1197	1273	
EU	ELECTRICALLY UNLOCKED								
KEYED SINGLE CYLINDER, WITH DEADBOLT									
A	ENTRANCE	F08, F10							
B	ENTRANCE	F21							
F	DORMITORY	F12	812	849	852	889	911	986	
FS	DORMITORY								
FW	DORMITORY	F13							
FD	APARTMENT	F20							
H	HOTEL	F15	833	870	873	911	933	1007	
LH	SPECIAL PRIVACY								
KEYED DOUBLE CYLINDER, NO DEADBOLT									
G	APARTMENT	F09							
GC	INTRUDER LATCHBOLT	F32							
GG	CLASSROOM SECURITY		842	879	882	919	941	1015	
GR	CLASSROOM SECURITY w/HOLDBACK								
WW	INSTITUTIONAL	F30							
KEYED DOUBLE CYLINDER, WITH DEADBOLT									
AC	ENTRANCE	F35							
C	STOREROOM	F14							
FC	INTRUDER DEADBOLT	F34	842	879	882	919	941	1015	
FA	DORMITORY	F11							
FX	DORMITORY	F33							
KEYLESS									
N	PASSAGE	F01	705	742	745	782	805	879	
L	BATHROOM	F02							
LF	PRIVACY	F19	812	849	852	889	912	986	
LJ	PRIVACY	F22							
EX	EXIT	F31	755	792	795	832	918	929	
DUMMY TRIM									
DI	DUMMY TRIM INSIDE								
DO	DUMMY TRIM OUTSIDE		355	374	375	394	405	449	
DT	FULLY DUMMY		710	747	750	788	810	884	

KNOBS & LEVERS ARE PACKED 6 PER CASE



NOTE: Split designs and/or finishes are priced at the highest design and/or finish • Special finishes, consult factory

DAVOS PLATE DESIGN DV

	ANSI-A156.13 • Grade 2		Series 7 • 2-3/4" Backset Series 9 • 2-1/2" Backset					
	Standard Features		KNOBS			LEVERS		
	<ul style="list-style-type: none"> • Thru-bolted screwless knob/lever plate • Independent spring loaded captivated spindles • Reversible mortise lock 2-1/2" or 2-3/4" backset • Lever support springs • Lock front Series 7: 1-1/4" x 8", Series 9: 1-1/16" x 7-5/8" • Dimensions: Ext: 11" H x 2-1/2" W, Int: 11" H x 2-1/2" W • Cylinder: MARKS "C" keyway, 6 pin w/ 2 keys • Concealed 5 pin cylinder (option A12) 		10, 20		30, 60		031, 44, 55, 57, 72, 77, 78, 82, 83, 86, 92, 96	
FINISH GROUPS								
MARKS #	FUNCTION	ANSI #	3, 26D, 32D	10, 10B,32	3E, 15, 26D	10, 10B,14	3E, 15, 26D	10E, 10B, 14, 19E, 26
KEYED SINGLE CYLINDER, NO DEADBOLT								
D	OFFICE VEST.		766	803	807	844	866	940
DW	VESTIBULE							
KEYED SINGLE CYLINDER, WITH DEADBOLT								
A	ENTRANCE	F08, F10	780	817	820	858	880	954
B	ENTRANCE	F21						
F	DORMITORY	F12						
FS	DORMITORY							
KEYED DOUBLE CYLINDER, WITH DEADBOLT								
AC	ENTRANCE	F35	810	847	850	887	909	984
C	STOREROOM	F14						
FX	DORMITORY	F33						
KEYLESS								
N	PASSAGE	F01	673	710	713	750	723	847
L	BATHROOM	F02	780	817	820	855	880	954
LF	PRIVACY	F19						
DUMMY TRIM								
DI	DUMMY TRIM INSIDE		355	374	375	394	405	461
DO	DUMMY TRIM OUTSIDE							
DT	FULLY DUMMY		710	737	750	788	810	884
NOTE: Split designs and/or finishes are priced at the highest design and/or finish • Special finishes, consult factory								

KNOBS	Round Knob 10	Ball Knob 20	Ball Knob 30	Eclipse Knob 60
	Stanhope Lever 44	Copa Lever 031	Brompton Lever 55	Monaco Lever 57 Specify handing
LEVERS	Towne Lever 72	Maxwell Lever 77	Omni Lever 78	Plaza Lever 82 Specify handing
	Dayton Lever 83 Specify handing	Crescent Lever 86	American Lever 92	Titan Lever 96

MADISON PLATE DESIGN MA

	ANSI-A156.13 • Grade 1 3 Hour Fire Rating			Series 5 • 2-3/4" Backset Series 55 • 2-1/2" Backset	
	Standard Features			KNOBS	LEVERS
	<ul style="list-style-type: none"> • Thru-bolted screwless knob/lever plate assemblies • Independent spring loaded captivated spindles • Reversible mortise lock 2-1/2" or 2-3/4" backset • Lever support springs • Lock front: 1-1/4" x 8" • Dimensions: Ext: 10-1/2" H x 2-5/32" W, Int: 10-1/2" H x 2-5/32" W • Cylinder: MARKS "C" keyway, 6 pin w/ 2 keys • Height: 13/32" 			30, 60	031, 44, 55, 57, 72, 77, 78, 82, 83, 86, 92, 96
FINISH GROUPS					
MARKS #	FUNCTION	ANSI #	3E & 15	3E & 15	
KEYED SINGLE CYLINDER, NO DEADBOLT					
D	OFFICE VEST.				
DW	VESTIBULE				
E	OFFICE	F04			
EW	STOREROOM	F07	844	880	
J	CLASSROOM	F05			
JM, JR	HOSPITAL	F06			
GL	INSTIT. PRIVACY	F26			
EL	ELECTRICALLY LOCKED		1177	1212	
EU	ELECTRICALLY UNLOCKED				
KEYED SINGLE CYLINDER, WITH DEADBOLT					
A	ENTRANCE	F08, F10			
B	ENTRANCE	F21			
F	DORMITORY	F12	860	895	
FS	DORMITORY				
FW	DORMITORY	F13			
FD	APARTMENT	F20	883	916	
H	HOTEL	F15			
LH	SPECIAL PRIVACY				
KEYED DOUBLE CYLINDER, NO DEADBOLT					
G	APARTMENT	F09			
GC	INTRUDER LATCHBOLT	F32			
GG	CLASSROOM SECURITY		891	928	
GR	CLASSROOM SECURITY w/HOLDBACK				
WW	INSTITUTIONAL	F30			
KEYED DOUBLE CYLINDER, WITH DEADBOLT					
AC	ENTRANCE	F35			
C	STOREROOM	F14			
FC	INTRUDER DEADBOLT	F34	891	928	
FA	DORMITORY	F11			
FX	DORMITORY	F33			
KEYLESS					
N	PASSAGE	F01	742	776	
L	BATHROOM	F02	860	895	
LF	PRIVACY	F19			
LJ	PRIVACY	F22	796	832	
EX	EXIT	F31			
DUMMY TRIM					
DI	DUMMY TRIM INSIDE		374	406	
DO	DUMMY TRIM OUTSIDE				
DT	FULLY DUMMY		747	782	







KNOBS & LEVERS ARE PACKED 6 PER CASE

NOTE: Split designs and/or finishes are priced at the highest design and/or finish • Special finishes, consult factory



MADISON PLATE DESIGN MA

	ANSI-A156.13 • Grade 2		Series 7 • 2-3/4" Backset Series 9 • 2-1/2" Backset	
	Standard Features		KNOBS	LEVERS
	<ul style="list-style-type: none"> • Thru-bolted screwless knob/lever plate assemblies • Independent spring loaded captivated spindles • Reversible mortise lock 2-1/2" or 2-3/4" backset • Lever support springs • Lock front Series 7: 1-1/4" x 8", Series 9: 1-1/16" x 7-5/8" • Dimensions: Ext: 10-1/2" H x 2-5/32" W, Int: 10-1/2" H x 2-5/32" W • Cylinder: MARKS "C" keyway, 6 pin w/ 2 keys • Height: 13/32" 		30, 60	031, 44, 55, 57, 72, 77, 78, 82, 83, 86, 92, 96
FINISH GROUPS				
MARKS #	FUNCTION	ANSI #	3E & 15	3E & 15
KEYED SINGLE CYLINDER, NO DEADBOLT				
D	OFFICE VEST.		810	845
DW	VESTIBULE			
KEYED SINGLE CYLINDER, WITH DEADBOLT				
A	ENTRANCE	F08, F10	825	860
B	ENTRANCE	F21		
F	DORMITORY	F12		
FS	DORMITORY			
FW	DORMITORY	F13		
KEYED DOUBLE CYLINDER, WITH DEADBOLT				
AC	ENTRANCE	F35	858	893
C	STOREROOM	F14		
FX	DORMITORY	F33		
KEYLESS				
N	PASSAGE	F01	707	742
L	BATHROOM	F02	825	860
LF	PRIVACY	F19		
DUMMY TRIM				
DI	DUMMY TRIM INSIDE		374	406
DO	DUMMY TRIM OUTSIDE			
DT	FULLY DUMMY		747	782
NOTE: Split designs and/or finishes are priced at the highest design and/or finish • Special finishes, consult factory				

KNOBS & LEVERS ARE PACKED 6 PER CASE

KNOBS	Ball Knob 30	Eclipse Knob 60		
				
LEVERS	Stanhope Lever 44	Copa Lever 031	Brompton Lever 55	Monaco Lever 57 Specify handing
				
	Towne Lever 72	Maxwell Lever 77	Omni Lever 78	Plaza Lever 82 Specify handing
				
	Dayton Lever 83 Specify handing	Crescent Lever 86	American Lever 92	Titan Lever 96
				

NEW YORKER PLATE DESIGN NY

		ANSI-A156.13 • Grade 1 3 Hour Fire Rating				Series 5 • 2-3/4" Backset Series 55 • 2-1/2" Backset				
		Standard Features		KNOBS		LEVERS				
<ul style="list-style-type: none"> • Thru-bolted screwless knob/lever plate assemblies • Independent spring loaded captivated spindles • Reversible mortise lock 2-1/2" or 2-3/4" backset • Lever support springs • Lock front: 1-1/4" x 8" • Dimensions: Ext: 10" H x 2-3/4" W, *Int: 7" H x 2-1/4" W • Cylinder: MARKS "C" keyway, 6 pin w/ 2 keys • Thickness: 1/4" 				10, 20		30, 60		031, 44, 55, 57, 72, 77, 78, 82, 83, 86, 92, 96		
FINISH GROUPS										
MARKS #	FUNCTION	ANSI #	3	26D	3	26D	3	26D	3	26D
KEYED SINGLE CYLINDER, NO DEADBOLT										
D	OFFICE VEST.									
DW	VESTIBULE									
E	OFFICE	F04								
EW	STOREROOM	F07	419	457	474	511	516	554		
J	CLASSROOM	F05								
JM, JR	HOSPITAL	F06								
GL	INSTIT. PRIVACY	F26								
EL	ELECTRICALLY LOCKED		767	806	823	860	865	903		
EU	ELECTRICALLY UNLOCKED									
KEYED SINGLE CYLINDER, WITH DEADBOLT										
A	ENTRANCE	F08, F10								
B	ENTRANCE	F21								
F	DORMITORY	F12	436	471	491	528	533	571		
FS	DORMITORY									
FW	DORMITORY	F13								
FD	APARTMENT	F20								
H	HOTEL	F15	460	498	515	552	558	596		
LH	SPECIAL PRIVACY									
KEYED DOUBLE CYLINDER, NO DEADBOLT										
G	APARTMENT	F09								
GC	INTRUDER LATCHBOLT	F32								
GG	CLASSROOM SECURITY		469	516	524	561	566	604		
GR	CLASSROOM SECURITY w/HOLDBACK									
WW	INSTITUTIONAL	F30								
KEYED DOUBLE CYLINDER, WITH DEADBOLT										
AC	ENTRANCE	F35								
C	STOREROOM	F14								
FC	INTRUDER DEADBOLT	F34	469	507	524	561	566	604		
FA	DORMITORY	F11								
FX	DORMITORY	F33								
KEYLESS										
N	PASSAGE	F01	311	349	366	403	408	446		
L	BATHROOM	F02	436	471	491	528	533	571		
LF	PRIVACY	F19								
LJ	PRIVACY	F22	369	407	424	461	466	505		
EX	EXIT	F31								
DUMMY TRIM										
DI	DUMMY TRIM INSIDE		159	178	187	205	210	248		
DO	DUMMY TRIM OUTSIDE									
DT	FULLY DUMMY		317	355	372	409	414	453		

KNOBS & LEVERS ARE PACKED 6 PER CASE

NOTE: Split designs and/or finishes are priced at the highest design and/or finish • Special finishes, consult factory



* Large interior plate available (10" H x 2-3/4" W)

NEW YORKER PLATE DESIGN NY

	ANSI-A156.13 • Grade 2		Series 7 • 2-3/4" Backset Series 9 • 2-1/2" Backset					
	Standard Features		KNOB			LEVERS		
	<ul style="list-style-type: none"> • Thru-bolted screwless knob/lever plate assemblies • Independent spring loaded captivated spindles • Reversible mortise lock 2-1/2" or 2-3/4" backset • Lever support springs • Lock front Series 7: 1-1/4" x 8"; Series 9: 1-1/16" x 7-5/8" • Dimensions: Ext: 10" H x 2-3/4" W, *Int: 7" H x 2-1/4" W • Cylinder: MARKS "C" keyway, 6 pin w/ 2 keys 		10, 20		30, 60		031, 44, 55, 57, 72, 77, 78, 82, 83, 86, 92, 96	
MARKS #	FUNCTION	ANSI #	FINISH GROUPS					
			3	26D	3	26D	3	26D
KEYED SINGLE CYLINDER, NO DEADBOLT								
D	OFFICE VEST.		387	425	442	479	495	533
DW	VESTIBULE							
KEYED SINGLE CYLINDER, WITH DEADBOLT								
A	ENTRANCE	F08, F10	404	439	459	496	501	540
B	ENTRANCE	F21						
F	DORMITORY	F12						
FS	DORMITORY							
FW	DORMITORY	F13						
KEYED DOUBLE CYLINDER, WITH DEADBOLT								
AC	ENTRANCE	F35	437	475	492	529	534	572
C	STOREROOM	F14						
FX	DORMITORY	F33						
KEYLESS								
N	PASSAGE	F01	279	317	334	371	376	414
L	BATHROOM	F02	404	439	459	496	545	583
LF	PRIVACY	F19						
DUMMY TRIM								
DI	DUMMY TRIM INSIDE		159	178	187	205	210	248
DO	DUMMY TRIM OUTSIDE							
DT	FULLY DUMMY		317	343	372	409	414	453
KNOB & LEVERS ARE PACKED 6 PER CASE								
NOTE: Split designs and/or finishes are priced at the highest design and/or finish • Special finishes, consult factory * Large interior plate available (10" H x 2-3/4" W)								

KNOB	Round Knob 10	Ball Knob 20	Ball Knob 30	Eclipse Knob 60
				
	Stanhope Lever 44	Copa Lever 031	Brompton Lever 55	Monaco Lever 57 Specify handing
				
LEVER	Towne Lever 72	Maxwell Lever 77	Omni Lever 78	Plaza Lever 82 Specify handing
				
	Dayton Lever 83 Specify handing	Crescent Lever 86	American Lever 92	Titan Lever 96
				

TOWNE PLATE DESIGN TN



		ANSI-A156.13 • Grade 1 3 Hour Fire Rating		Series 5 • 2-3/4" Backset Series 55 • 2-1/2" Backset			
	Standard Features		KNOBS		LEVERS		
	<ul style="list-style-type: none"> • Thru-bolted screwless knob/lever plate assemblies • Independent spring loaded captivated spindles • Reversible mortise lock 2-1/2" or 2-3/4" backset • Lever support springs • Lock front: 1-1/4" x 8" • Dimensions: Ext: 9-1/4" H x 2-1/4" W, Int: 9-1/4" H x 2-1/4" W • Cylinder: MARKS "C" keyway, 6 pin w/ 2 keys • Thickness: 13/32" 		30, 60		031, 44, 55, 57, 72, 77, 78, 82, 83, 86, 92, 96		
MARKS #		FUNCTION	ANSI #	3E & 15	26	3E & 15	26
KEYED SINGLE CYLINDER, NO DEADBOLT							
D	OFFICE VEST.			844	881	889	928
DW	VESTIBULE						
E	OFFICE	F04					
EW	STOREROOM	F07					
J	CLASSROOM	F05					
JM, JR	HOSPITAL	F06					
GL	INSTIT. PRIVACY	F26					
EL	ELECTRICALLY LOCKED			1194	1231	1238	1276
EU	ELECTRICALLY UNLOCKED						
KEYED SINGLE CYLINDER, WITH DEADBOLT							
A	ENTRANCE	F08, F10		861	898	906	942
B	ENTRANCE	F21					
F	DORMITORY	F12					
FS	DORMITORY						
FW	DORMITORY	F13					
FD	APARTMENT	F20		885	919	823	967
H	HOTEL	F15					
LH	SPECIAL PRIVACY						
KEYED DOUBLE CYLINDER, NO DEADBOLT							
G	APARTMENT	F09		895	932	940	977
GC	INTRUDER LATCHBOLT	F32					
GG	CLASSROOM SECURITY						
GR	CLASSROOM SECURITY w/HOLDBACK						
WW	INSTITUTIONAL	F30					
KEYED DOUBLE CYLINDER, WITH DEADBOLT							
AC	ENTRANCE	F35		895	932	940	977
C	STOREROOM	F14					
FC	INTRUDER DEADBOLT	F34					
FA	DORMITORY	F11					
FX	DORMITORY	F33					
KEYLESS							
N	PASSAGE	F01		738	773	782	818
L	BATHROOM	F02		861	898	906	942
LF	PRIVACY	F19					
LJ	PRIVACY	F22		794	832	840	878
EX	EXIT	F31					
DUMMY TRIM							
DI	DUMMY TRIM INSIDE			371	406	394	431
DO	DUMMY TRIM OUTSIDE						
DT	FULLY DUMMY			743	779	789	826
KNOBS & LEVERS ARE PACKED 6 PER CASE							
NOTE: Split designs and/or finishes are priced at the highest design and/or finish • Special finishes, consult factory							

TOWNE PLATE DESIGN TN

	ANSI-A156.13 • Grade 2		Series 7 • 2-3/4" Backset Series 9 • 2-1/2" Backset			
	Standard Features		KNOBS		LEVERS	
	<ul style="list-style-type: none"> • Thru-bolted screwless knob/lever plate assemblies • Independent spring loaded captivated spindles • Reversible mortise lock 2-1/2" or 2-3/4" backset • Lever support springs • Lock front Series 7: 1-1/4" x 8"; Series 9: 1-1/16" x 7-5/8" • Dimensions: Ext: 9-1/4" H x 2-1/4" W, Int: 9-1/4" H x 2-1/4" W • Cylinder: MARKS "C" keyway, 6 pin w/ 2 keys 		30, 60		031, 44, 55, 57, 72, 77, 78, 82, 83, 86, 92, 96	
		FINISH GROUPS				
MARKS #	FUNCTION	ANSI #	3E & 15	26	3E & 15	26
KEYED SINGLE CYLINDER, NO DEADBOLT						
D	OFFICE VEST.		770	803	813	847
DW	VESTIBULE					
KEYED SINGLE CYLINDER, WITH DEADBOLT						
A	ENTRANCE	F08, F10	784	819	827	863
B	ENTRANCE	F21				
F	DORMITORY	F12				
FS	DORMITORY					
FW	DORMITORY	F13				
KEYED DOUBLE CYLINDER, WITH DEADBOLT						
AC	ENTRANCE	F35	817	851	861	895
C	STOREROOM	F14				
FX	DORMITORY	F33				
KEYLESS						
N	PASSAGE	F01	667	707	709	744
L	BATHROOM	F02	784	819	827	863
LF	PRIVACY	F19				
DUMMY TRIM						
DI	DUMMY TRIM INSIDE		371	406	394	431
DO	DUMMY TRIM OUTSIDE					
DT	FULLY DUMMY		743	779	789	826
KNOBES & LEVERS ARE PACKED 6 PER CASE						
NOTE: Split designs and/or finishes are priced at the highest design and/or finish • Special finishes, consult factory						

KNOBES	Ball Knob 30	Eclipse Knob 60		
				
LEVERS	Stanhope Lever 44	Copa Lever 031	Brompton Lever 55	Monaco Lever 57 Specify handing
				
	Towne Lever 72	Maxwell Lever 77	Omni Lever 78	Plaza Lever 82 Specify handing
				
	Dayton Lever 83 Specify handing	Crescent Lever 86	American Lever 92	Titan Lever 96
				

ROSE DESIGN RR, RW, RQ, RS, RX*, RK*, RL*

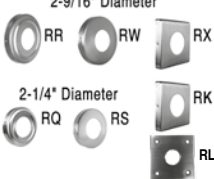
	ANSI-A156.13 • Grade 1 3 Hour Fire Rating		Series 5 • 2-3/4" Backset Series 55 • 2-1/2" Backset						
			Standard Features		KNOBS		LEVERS		
	<ul style="list-style-type: none"> • Thru-bolted screwless knob/lever rose assemblies • Independent spring loaded captivated spindles • Reversible mortise lock 2-1/2" or 2-3/4" backset • Lever support springs • Lock front: 1-1/4" x 8" • Cylinder: MARKS "C" keyway, 6 pin w/ 2 keys 		10, 20	30, 60	031, 44, 55, 57, 72, 77, 78, 82, 83, 86, 92, 96			82, 83, 86, 92, 96	
			FINISH GROUPS						
MARKS #	FUNCTION	ANSI #	3, 32D	3E, 15	26, 10B	3, 4, 15, 26D	14, 26, 32	10E, 10B, 19E	32D
KEYED SINGLE CYLINDER, NO DEADBOLT									
D	OFFICE VEST.								
DW	VESTIBULE								
E	OFFICE	F04							
EW	STOREROOM	F07	560	618	655	596	633	670	596
J	CLASSROOM	F05							
JM, JR	HOSPITAL	F06							
GL	INSTIT. PRIVACY	F26							
EL	ELECTRICALLY LOCKED		876	934	971	912	949	975	912
EU	ELECTRICALLY UNLOCKED								
KEYED SINGLE CYLINDER, WITH DEADBOLT									
A	ENTRANCE	F08, F10							
B	ENTRANCE	F21							
F	DORMITORY	F12	573	632	669	610	647	673	610
FS	DORMITORY								
FW	DORMITORY	F13							
FD	APARTMENT	F20							
H	HOTEL	F15	595	653	690	631	668	694	631
LH	SPECIAL PRIVACY								
KEYED DOUBLE CYLINDER, NO DEADBOLT									
G	APARTMENT	F09							
GC	INTRUDER LATCHBOLT	F32							
GG	CLASSROOM SECURITY		603	661	699	639	676	703	639
GR	CLASSROOM SECURITY w/HOLDBACK								
WW	INSTITUTIONAL	F30							
KEYED DOUBLE CYLINDER, WITH DEADBOLT									
AC	ENTRANCE	F35							
C	STOREROOM	F14							
FC	INTRUDER DEADBOLT	F34	603	661	699	639	676	703	639
FA	DORMITORY	F11							
FX	DORMITORY	F33							
KEYLESS									
N	PASSAGE	F01	435	554	591	547	584	591	547
L	BATHROOM	F02							
LF	PRIVACY	F19	573	632	669	610	647	673	610
LJ	PRIVACY	F22							
EX	EXIT	F31	516	575	612	552	589	616	552
DUMMY TRIM									
DI	DUMMY TRIM INSIDE		117	145	164	135	153	166	135
DO	DUMMY TRIM OUTSIDE								
DT	FULLY DUMMY		232	290	328	268	305	332	268
KNOB & LEVERS ARE PACKED 6 PER CASE NOTE: Split designs and/or finishes are priced at the highest design and/or finish • Special finishes, consult factory F17 Dummy Cylinder: Add \$44.00 *Square Rose RX: Add \$30 / *Square Rose RZ: Add \$70 / *Square Rose RK: Add \$100									

ROSE DESIGN RR, RW, RQ, RS, RX*, RK*, RL*



Diameter RR RW RX Diameter RQ RS RK		ANSI-A156.13 • Grade 2	Series 7 • 2-3/4" Backset Series 9 • 2-1/2" Backset							
MARKS #		FUNCTION	ANSI #	KNOBS			LEVERS			
		<ul style="list-style-type: none"> • Thru-bolted screwless knob/lever rose assemblies • Independent spring loaded captivated spindles • Reversible mortise lock 2-1/2" or 2-3/4" backset • Lever support springs • Lock front Series 7: 1-1/4" x 8"; Series 9: 1-1/16" x 7-5/8" • Cylinder: MARKS "C" keyway, 6 pin w/ 2 keys 		10, 20	30, 60		031, 44, 55, 57, 72, 77, 78, 82, 83, 86, 92, 96		82, 83, 86, 92, 96	
FINISH GROUPS										
				3, 32D	3E, 15	26, 10B	3, 4, 15, 26D	14, 26, 32	10E, 10B, 19E	32D
KEYED SINGLE CYLINDER, NO DEADBOLT										
D		OFFICE VEST.		528	586	615	564	601	628	564
DW		VESTIBULE								
KEYED SINGLE CYLINDER, WITH DEADBOLT										
A		ENTRANCE	F08, F10	542	600	637	578	615	641	578
B		ENTRANCE	F21							
F		DORMITORY	F12							
FS		DORMITORY								
FW		DORMITORY	F13							
KEYED DOUBLE CYLINDER, WITH DEADBOLT										
AC		ENTRANCE	F35	571	630	667	607	644	671	607
C		STOREROOM	F14							
FX		DORMITORY	F33							
KEYLESS										
N		PASSAGE	F01	435	493	530	471	508	534	471
L		BATHROOM	F02	542	600	637	578	675	641	578
LF		PRIVACY	F19							
DUMMY TRIM										
DI		DUMMY TRIM INSIDE		117	145	164	135	153	166	135
DO		DUMMY TRIM OUTSIDE								
DT		FULLY DUMMY		232	240	328	268	305	332	268
NOTE: Split designs and/or finishes are priced at the highest design and/or finish • Special finishes, consult factory										
*Square Rose RX: Add \$30 / *Square Rose RZ: Add \$70 / *Square Rose RK: Add \$100										

KNOBS	Round Knob 10	Ball Knob 20	Ball Knob 30	Eclipse Knob 60	ROSES	RR: 2-9/16" dia.
LEVERS	Stanhope Lever 44	Copa Lever 031	Brompton Lever 55	Monaco Lever 57 Specify handing		RQ: 2-1/4" dia.
						RS: 2-1/4" dia.
	Towne Lever 72	Maxwell Lever 77	Omni Lever 78	Plaza Lever 82 Specify handing		
					RX: 2-1/2" sq.	RK: 2-1/2" sq.
	Crescent Lever 86	American Lever 92	Titan Lever 96			
				Wrought	Forged	

CROWN HANDLESET DESIGN CR

UL LISTED C	CR	ANSI-A156.13 • Grade 1 3 Hour Fire Rating		Series 4 • 2-3/4" Backset Series 45 • 2-1/2" Backset		Series 6 • 2-3/4" Backset Series 8 • 2-1/2" Backset		
		Standard Features		KNOB	LEVER	KNOB	LEVER	
		<ul style="list-style-type: none"> Exterior handle plate assemblies with thru-posts Interior thru-bolted screwless knob/lever plate assemblies Independent spring loaded captivated spindles Reversible mortise lock 2-1/2" or 2-3/4" backset Lever support springs • Lock front Series 4, 45: 1-1/4" x 8" Lock front Series 6: 1-1/4" x 8"; Series 8: 1-1/16" x 7-5/8" Dimensions: CROWN Ext: 16" H x 2" W, Int: 8-1/2" H x 2" W Dimensions: GRAND CROWN Ext: 16" H x 2" W, Int: 8-1/2" H x 2" W Cylinder: MARKS "C" keyway, 6 pin w/ 2 keys Thickness: 13/32" 		30, 60	031, 44, 55, 57, 72, 77, 78, 82, 83, 86, 92, 96	30, 60	031, 44, 55, 57, 72, 77, 78, 82, 83, 86, 92, 96	
BMAHBM CERTIFIED		FINISH GROUPS		FINISH GROUPS		FINISH GROUPS		
GRADE 1 HANDLESETS	MARKS #	FUNCTION	ANSI #	3E & 15		3E & 15		
	KEYED SINGLE CYLINDER, NO DEADBOLT							
	D	OFFICE VEST.		1185		1126		
	DW	VESTIBULE		1185		1126		
	EW	STOREROOM	F07	1185		1126		
	KEYED SINGLE CYLINDER, WITH DEADBOLT							
	A	ENTRANCE	F08, F10	1199		1141		
	B	ENTRANCE	F21	1199		1141		
	F	DORMITORY	F12	1199		1141		
	KEYED DOUBLE CYLINDER, WITH DEADBOLT							
	AC	ENTRANCE	F35	1232		1173		
	C	STOREROOM	F25	1232		1173		
G	APARTMENT	F24	1232		1173			
SO	STOREROOM: DOUBLE HANDLESET ONLY	F25	1526		1467			
DUMMY TRIM								
DT	FULLY DUMMY		966		966			

HANDLESETS ARE PACKED 6 PER CASE
 NOTE: Split designs and/or finishes are priced at the highest design and/or finish • Special finishes, consult factory
 SO Function Double Handleset ONLY * SERIES 45 NOT AVAILABLE IN "SO" FUNCTION

KNOB	Ball Knob 30	Eclipse Knob 60
		

LEVER	Stanhope Lever 44	Copa Lever 031	Brompton Lever 55	Monaco Lever 57 Specify handing
				
	Towne Lever 72	Maxwell Lever 77	Omni Lever 78	Plaza Lever 82 Specify handing
				
	Dayton Lever 83 Specify handing	Crescent Lever 86	American Lever 92	Titan Lever 96
				

TOWNE HANDLESET DESIGN TN



	ANSI-A156.13 • Grade 1 3 Hour Fire Rating		Series 4 • 2-3/4" Backset Series 45 • 2-1/2" Backset	Series 6 • 2-3/4" Backset Series 8 • 2-1/2" Backset	
	Standard Features		KNOBS	LEVERS	KNOBS
<ul style="list-style-type: none"> • Exterior handle plate assemblies with thru-posts • Interior thru-bolted screwless knob/lever plate assemblies • Independent spring loaded captivated spindles • Reversible mortise lock 2-1/2" or 2-3/4" backset • Lever support springs • Lock front Series 4, 45: 1-1/4" x 8" • Lock front Series 6: 1-1/4" x 8"; Series 8: 1-1/16" x 7-5/8" • Dimensions: TOWNE Ext: 16-3/8" H x 2-1/4" W, Int: 9-1/4" H x 2-1/4" W • Dimensions: • Cylinder: MARKS "C" keyway, 6 pin w/ 2 keys • Thickness: 13/32" 		30, 60	031, 44, 55, 57, 72, 77, 78, 82, 83, 86, 92, 96	30, 60	031, 44, 55, 57, 72, 77, 78, 82, 83, 86, 92, 96
		FINISH GROUPS		FINISH GROUPS	
MARKS #	FUNCTION	ANSI #	3E & 15		3E & 15
GRADE 1 HANDLESETS					
KEYED SINGLE CYLINDER, NO DEADBOLT					
D	OFFICE VEST.		1185		1126
DW	VESTIBULE				
EW	STOREROOM	F07	1185		
KEYED SINGLE CYLINDER, WITH DEADBOLT					
A	ENTRANCE	F08, F10			
B	ENTRANCE	F21	1199		1141
F	DORMITORY	F12			
KEYED DOUBLE CYLINDER, WITH DEADBOLT					
AC	ENTRANCE	F35			
C	STOREROOM	F25	1232		1173
G	APARTMENT	F24	1232		
SO	STOREROOM: DOUBLE HANDLESET ONLY	F25	1526		1467
DUMMY TRIM					
DT	FULLY DUMMY		966		966

GRADE 2 HANDLESETS

HANDLESETS ARE PACKED 6 PER CASE

NOTE: Split designs and/or finishes are priced at the highest design and/or finish • Special finishes, consult factory

SO Function Double Handleset ONLY * SERIES 45 NOT AVAILABLE IN "SO" FUNCTION

KNOBS	Ball Knob 30	Eclipse Knob 60
		

LEVERS	Stanhope Lever 44	Copa Lever 031	Brompton Lever 55	Monaco Lever 57 Specify handing
				
	Towne Lever 72	Maxwell Lever 77	Omni Lever 78	Plaza Lever 82 Specify handing
				
	Dayton Lever 83 Specify handing	Crescent Lever 86	American Lever 92	Titan Lever 96
				

ORNAMENTAL IRON

Ornamental Iron

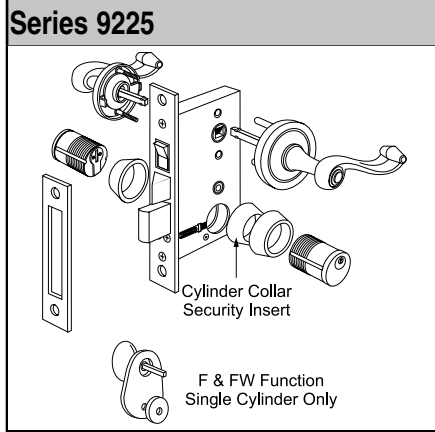
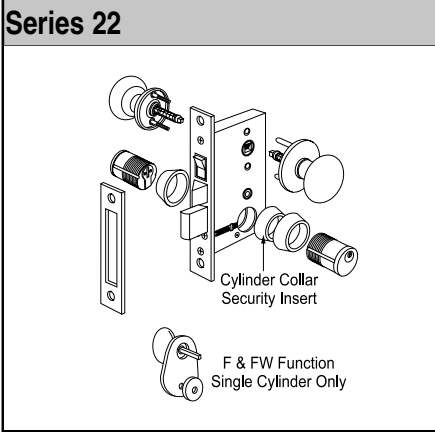
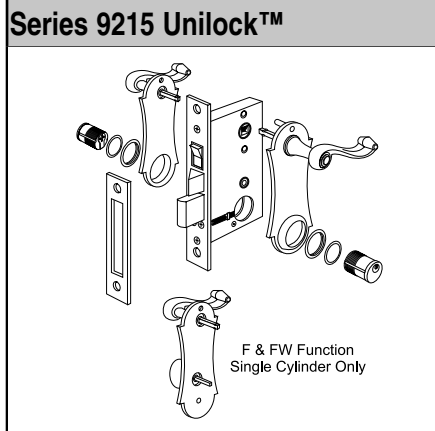
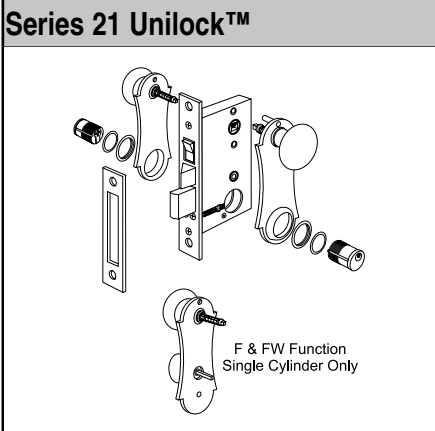

Standard Features		SERIES		
<ul style="list-style-type: none"> • Thru-bolted solid brass trim assemblies • Spring loaded captivated spindles • Reversible mortise lock 1" backset • 1" bolt, 1/2" latch projection • Cylinder: Marks "A" keyway, 5 pin w/ 2 keys; keyed alike - 6 		2750 THINLINE®		
		FINISH GROUPS		
MARKS #	FUNCTION	3	10B	5, 26D
KEYED WITH DEADBOLT				
B	ENTRANCE CYLINDER x TURNPIECE	207	261	233
C	ENTRANCE DOUBLE CYLINDER			
DUMMY TRIM				
DT	FULL DUMMY	125	174	145
ORNAMENTAL IRON LOCKSETS PACKED 6 PER CASE				
OPTIONS - Series 2750		CODE	PRICE	
For 1-3/4" doors		D4	NC	
Marks "C" keyway		G5	16	

Standard Features		SERIES 21 UNILOCK™ SERIES 22			SERIES 9215 UNILOCK™ SERIES 9225		
<ul style="list-style-type: none"> • Door thickness: 1" • Series 9 lock body, Backset: 2-1/2" • Reversible mortise lock 1" bolt, 1/2" latch projection • Lock front Series 7: 1-1/4" x 8"; Series 9: 1-1/16" x 7-5/8" • Thru-bolted solid brass trim assemblies • Spring loaded captivated spindles • Cylinder: Marks "A" keyway, 5 pin w/ 2 keys; keyed alike-6 		FINISH GROUPS					
MARKS #	FUNCTION	3	10B	5, 26D	3	10B	5, 26D
KEYED SINGLE CYLINDER, WITH DEADBOLT							
DW	SINGLE CYL. PANIC PROOF						
F	SINGLE CYL. PANIC PROOF	278	332	296	371	419	390
FW	SINGLE CYL. PANIC PROOF						
KEYED DOUBLE CYLINDER, WITH DEADBOLT							
AC	ENTRANCE	247	304	265	341	390	359
DUMMY TRIM							
DT	FULL DUMMY	165	228	177	265	321	278
ORNAMENTAL IRON LOCKSETS ARE PACKED 6 PER CASE							

OPTIONS	CODE	PRICE
Lock Front: 1" x 7-1/8" standard	W	NC
Mushroom knob interior; 1-7/8" prj.	A9	5
For 1-3/4" doors	D4	NC
Adjustable spring collars	F10	5

How To Order Example for Ornamental Iron Locksets					
9215	C	/	10B	-	D4
1. Lock Series	2. Marks Function	Slash	3. Finish	Dash	4. Options
LOCK SERIES (Pgs. 49 & 50)	MARKS FUNCTION (Pgs. 57-58)		FINISH (Pg. 10)	OPTIONS	
<input type="checkbox"/> 21 <input type="checkbox"/> 2750 <input type="checkbox"/> 22 <input type="checkbox"/> 9215	— B — AC — C — DT — F — DW		<input type="checkbox"/> 3 <input type="checkbox"/> 10B <input type="checkbox"/> 5 <input type="checkbox"/> 26D	<input type="checkbox"/> Special Specify • Keying • Handing • Door Thickness	

ORNAMENTAL IRON

Knob & Lever Kits

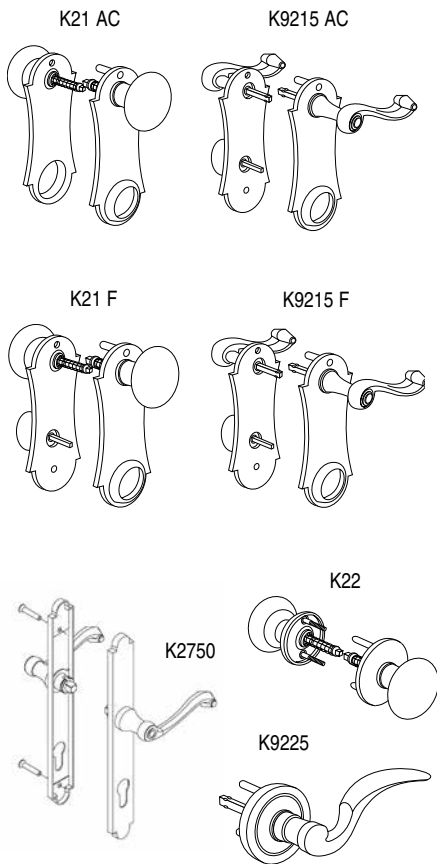

PART #	DESCRIPTION	FUNCTION	FINISH GROUPS			
			3	4	10B	5, 26D
K21AC	Ext./Int. UNILOCK™ knob/plate kit	AC	122	—	159	135
K21AC-M	Ext./Int. UNILOCK™ knob/plate kit (Mushroom Int.)	AC	137	—	164	141
K21F	Ext./Int. UNILOCK™ knob/plate kit assemblies	F	146	—	176	153
K21F-M	Ext./Int. UNILOCK™ knob/plate kit (Mushroom Int.)	F	151	—	182	159
K2750	LEVER PLATE TRIM SET		146	—	189	166
2600B	Thinline lock body, latch, deadbolt US 4 & 26D ONLY - Strike not included		—	121	189	166
K9215AC	Ext./Int. UNILOCK™ lever/plate kit assemblies	AC	184	—	218	195
K9215F	Ext./Int. UNILOCK™ lever/plate kit assemblies	F	184	—	239	216
A9214-M	UNILOCK™ mushroom knob/plate (w/cylinder hole)	AC	68	—	95	71
K9217-M	UNILOCK™ mushroom knob/plate (w/turnpiece)	F	119	—	145	122
K22	Ext./Int. knob/rose kit 1" thru 1-3/4" door		71	—	109	86
K22-M	Ext./Int. knob/rose kit (mushroom int.)		78	—	114	91
K9225	Ext./Int. lever/rose kit		180	—	212	189

Ornamental Iron

Accessories

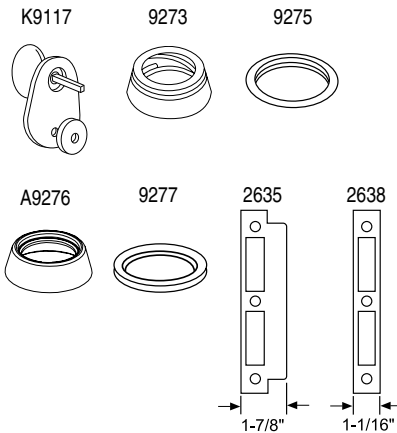

PART #	DESCRIPTION	FINISH GROUPS		
		NO FINISH	3	5, 26D
K9117	Turnpiece kit	—	47	50
A9223-M	Interior knob/rose assembly (mushroom knob)	—	40	47
9273	Spring collar, 7/16" high	—	12	12
9275	Mortise spacer, wrought brass, 1/8" high	—	6	—
A9276	Collar, wrought brass w/insert, 1/2" high	—	21	21
9277	Plastic spacer ring, 1/16"	1	—	—
2635	Curved lip strike, solid brass	—	24	15
2638	Flat strike, solid brass, no lip	—	15	7

Cylinders

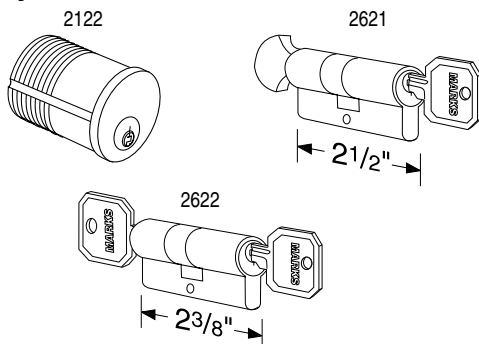

PART #	DESCRIPTION	FINISH GROUPS	
		3	5, 26D
2122-A	5 Pin mortise cylinder, "A" keyway, 15/16"	41	43
2621-A	Cylinder x turnpiece unit, "A" keyway	67	74
2622-A	double cylinder unit, "A" keyway	48	60
2122-C	5 Pin mortise cylinder, "C" keyway	41	43
2621-C	Cylinder x turnpiece unit, "C" keyway	67	74
2622-C	double cylinder unit, "C" keyway	48	60

MORTISE LOCK BODIES

AUTOREVERSE SERIES

**GRADE 1
MORTISE LOCKS EXCEEDS
BHMA
SPECIFICATIONS**

Mortise Parts, Trim

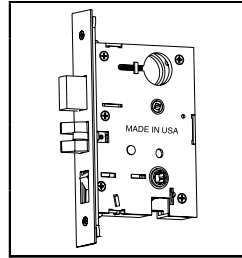
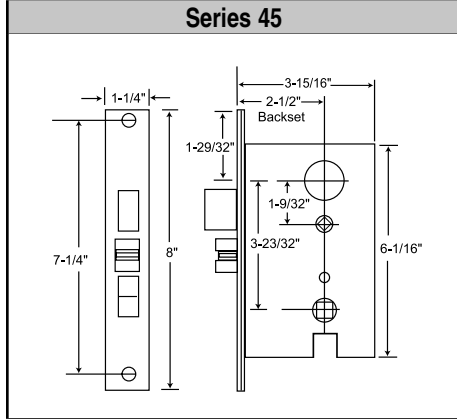
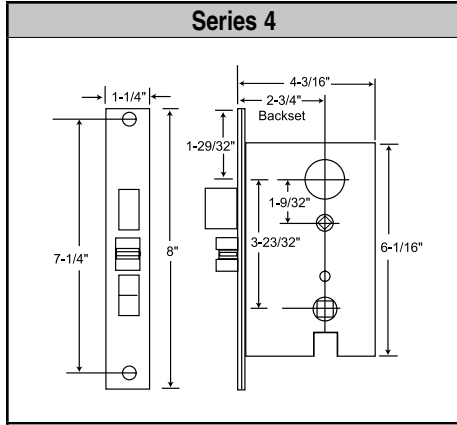

Standard Features		Grade 1 for Handlesets	
<ul style="list-style-type: none"> Backset: 4 Series 2-3/4"; 45 Series 2-1/2" Bolt throw: Stainless steel full 1" throw Latch throw: 3/4" (anti-friction) Auxiliary latch: 1/2" throw Case: Stamped steel .090 thick., Zinc dichromate finish Front: 1-1/4" x 8", Adjustable bevel Hubs: Steel, 9/32" on diamond 5/16" on square 		Series 4 • 2-3/4" Backset Series 45 • 2-1/2" Backset 	
MARKS #		FUNCTION	ANSI #
			3, 32D 10, 10B, 32

KEYED SINGLE CYLINDER, NO DEADBOLT			
DW	VESTIBULE		
EW	STOREROOM	F07	
EN	STOREROOM		
DN	STOREROOM		
			367 383
KEYED SINGLE CYLINDER, WITH DEADBOLT			
A	ENTRANCE	F08, F10	
B	ENTRANCE	F21	
F	DORMITORY	F12	
FD	APARTMENT	F20	
			378 395
			394 411
KEYED DOUBLE CYLINDER, NO DEADBOLT			
G	ENTRANCE	F09	
			394 411
KEYED DOUBLE CYLINDER, WITH DEADBOLT			
AC	ENTRANCE	F35	
C	STORE DOOR "B BODY"	F25	
SO	STORE DOOR*	F25	
			394 411

OPTIONS	CODE	PRICE
1-1/16" x 7-5/8" front	T	27
1-1/16" x 7-3/4" front	V	27
1-1/16" x 8" front	Q	27
Lever support springs w- 5/16" hubs	B4	19
Turnpiece hub on square	B8	11
Screws with Dust Box	B10	NC
Solid latch for electric strike	E1	20
Hold open latch	E2	37
Lead-lined mortise lock	F1	325
4-7/8" Strikes: 1 Left / 1 Right	S6	13

CYLINDER CAMS REQUIRED

Locks w/o deadbolt 2101 Straight Cam
 Locks w/ deadbolt 2102 Cloverleaf Cam

See pages 41 & 42 for additional cams per function

MORTISE LOCK BODIES ARE PACKED 12 PER CASE
 * SERIES 45 NOT AVAILABLE IN "SO" FUNCTION

MORTISE LOCK BODIES

AUTOREVERSE SERIES

GRADE 1
MORTISE LOCKS EXCEEDS
BHMA
SPECIFICATIONS

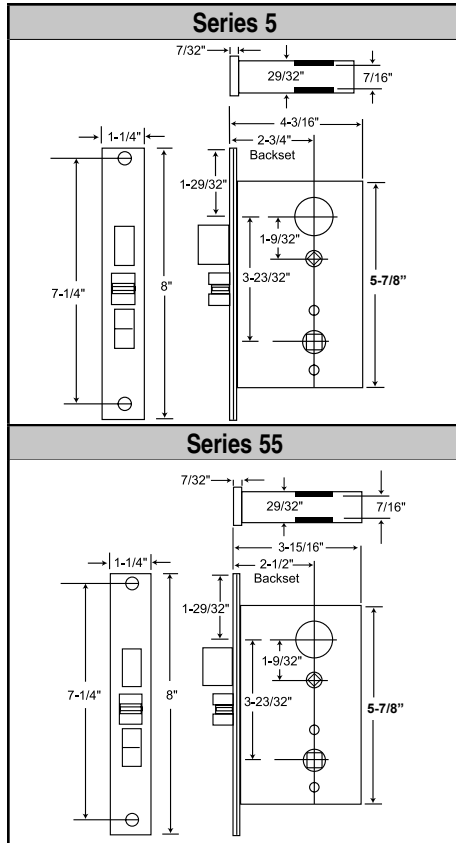

OPTIONS	CODE	PRICE
1-1/16" x 7-5/8" front	T	27
1-1/16" x 7-3/4" front	V	27
1-1/16" x 8" front	Q	27
Lever override guard outside (Series 5)	B1	44
Lever override guard both sides	B2	62
Lever support springs w- 5/16" hubs	B4	19
Hubs with hollow spacer (Series 55)	B6	18
Turnpiece hub on square	B8	11
Screws with Dust Box	B10	NC
Solid latch for electric strike	E1	20
Hold open latch	E2	37
Lead-lined mortise lock	F1	325
4-7/8" Strikes: 1 Left / 1 Right	S6	13
Request to exit switch (Series 5)	W10	136

CYLINDER CAMS REQUIRED	
Locks w/o deadbolt	2101 Straight Cam
Locks w/deadbolt	2102 Cloverleaf Cam
G function (ext. only)	2106 "G" Cam
G function (int. only)	2105 "J" Cam
J function	2105 "J" Cam

* 55 Series Lock Bodies are not available in autoreverse and electrified functions EL and EU.

MARKS #	FUNCTION	ANSI #	Grade 1 for	
			3, 32D	10, 10B, 32
			Standard Features • Backset: 5 Series 2-3/4"; 55 Series 2-1/2" • Bolt throw: Stainless steel full 1" throw • Latch throw: 3/4" (anti-friction) • Auxiliary latch: 1/2" throw • Case: Stamped steel .090 thick., Zinc dichromate finish • Front: 1-1/4" x 8", Adjustable bevel • Hubs: Steel, 9/32" on diamond 5/16" on square w/security separator	
			Grade 1 for Knobs & Levers Series 5 • 2-3/4" Backset Series 55 • 2-1/2" Backset 	
			FINISH GROUPS	
KEYED SINGLE CYLINDER, NO DEADBOLT				
D	OFFICE / VESTIBULE		308	403
DW	VESTIBULE			
E, Q, QH	OFFICE	F04		
K	OFFICE	F04		
EW	STOREROOM	F07		
J	CLASSROOM	F05		
JM, JR	HOSPITAL (HOLDBACK)	F06		
GL	INST. PRIVACY	F26		
MT	ArchITech		1113	1134
EL*	ELECTRICALLY LOCKED*		843	861
EU*		ELECTRICALLY UNLOCKED*		
KEYED SINGLE CYLINDER, WITH DEADBOLT				
A	ENTRANCE	F08, F10	323	341
B	ENTRANCE	F21		
F	DORMITORY	F12		
FS	DORMITORY			
FW	DORMITORY	F13		
FD	APARTMENT	F20	347	365
AD		F27		
H	HOTEL	F15		
LH	SPEC. PRIVACY			
KEYED DOUBLE CYLINDER, NO DEADBOLT				
G	ENTRANCE	F09	354	372
GC	INTRUDER LATCHBOLT	F32		
GG	CLASSROOM SECURITY			
GR	CLASSROOM SECURITY w/HOLDBACK			
WW	INSTITUTION	F30		
KEYED DOUBLE CYLINDER, WITH DEADBOLT				
AC	ENTRANCE	F35	354	372
C	STOREROOM	F14		
FC	INTRUDER DEADBOLT	F34		
FA	DORMITORY	F11		
FX	DORMITORY	F33		
KEYLESS				
N	PASSAGE	F01	253	271
L	BATHROOM	F02	323	341
LF	PRIVACY	F19		
LJ	PRIVACY	F19		
EX	EXIT	F31		
MORTISE LOCK BODIES ARE PACKED 6 PER CASE				
* Electrified Functions 5 SERIES ONLY; 2-3/4" Backset ONLY; 100% Duty Cycle 24V/DC, 12V/DC Optional supplied with bridge rectifier (350 ma)				

Mortise Parts, Trim

MORTISE LOCK BODIES

Mortise Parts, Trim

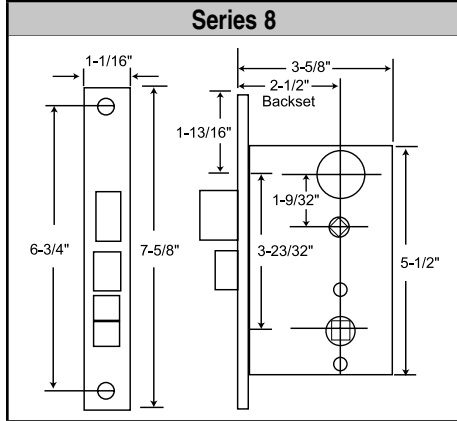
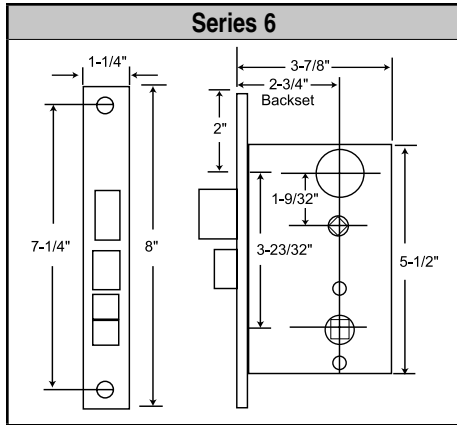

OPTIONS	CODE	PRICE
1-1/16" x 7-5/8" front	T	27
1-1/4" x 10" front, (A function, US 4 only), no mounting holes	U	109
1" x 7-1/8" front, (US 4 only)	W	NC
1-1/4" x 8" front	X	25
1-1/4" x 8-5/8" front (A function, US 4 only)	Y	109
Screws with Dust Box	B10	NC
Solid latch for electric strike	E1	20
4-7/8" Strikes: 1 Left / 1 Right	S6	13
Front 1" x 8"	Z	25

CYLINDER CAMS REQUIRED	
All Functions	2101 Straight Cam

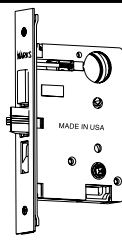
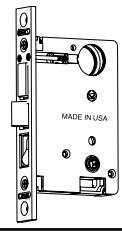
Series 6		Standard Features		
		<ul style="list-style-type: none"> Backset: 2-3/4" Bolt throw: Cast alloy full 1" throw Latch throw: 5/8" (anti-friction) Case: High pressure cast Zamac, baked enamel finish Front: 1-1/4" x 8", Flat or 3° bevel Hubs: 9/32" (7.2mm) on square 		
Series 8		Standard Features		
		<ul style="list-style-type: none"> Backset: 2-1/2" Bolt throw: Cast alloy full 1" throw Latch throw: Solid brass 1/2" throw, reversible Case: High pressure cast Zamac, baked enamel finish Front: 1-1/16" x 7-5/8", Flat or 3° bevel Hubs: 9/32" on square 		
MARKS #		FUNCTION	ANSI #	
KEYED SINGLE CYLINDER, NO DEADBOLT				
DW	VESTIBULE		313	330
KEYED SINGLE CYLINDER, WITH DEADBOLT				
A	ENTRANCE	F08, F10	325	342
B	ENTRANCE	F21		
F	DORMITORY	F12		
KEYED DOUBLE CYLINDER, WITH DEADBOLT				
AC	ENTRANCE	F35	341	358
C	STORE DOOR "B BODY"	F25		
SO	STORE DOOR	F25		
MORTISE LOCK BODIES ARE PACKED 6 PER CASE				

Grade 2 for
Handlesets

Series 6
2-3/4" Backset
Series 8
2-1/2" Backset

FINISH GROUPS

MORTISE LOCK BODIES

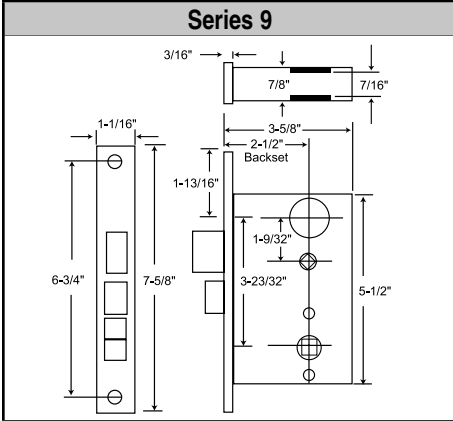
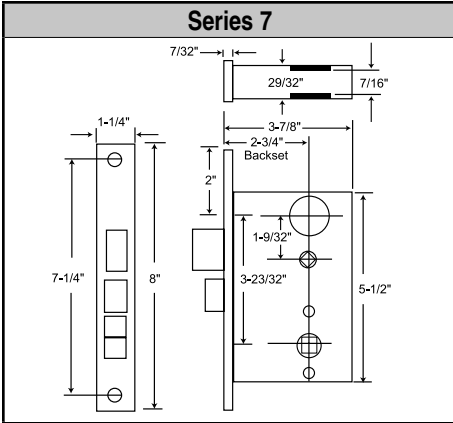

OPTIONS	CODE	PRICE
1-1/16" x 7-5/8" front	T	27
1-1/4" x 10" front, (A function, US 4 only), no mounting holes	U	109
1" x 7-1/8" front, (US 4 only)	W	NC
1-1/4" x 8" front	X	25
1-1/4" x 8-5/8" front (A function, US 4 only)	Y	109
1-1/16" x 8"	T	
Pin and lever springs	B5	37
Screws with Dust Box	B10	NC
Solid latch for electric strike	E1	20
4-7/8" Strikes: 1 Left / 1 Right	S6	13
Front 1" x 8"	Z	25

CYLINDER CAMS REQUIRED
All functions 2101 Straight Cam

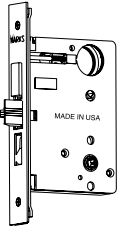
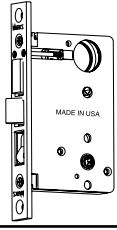
Series 7		Standard Features			
		<ul style="list-style-type: none"> Backset: 2-3/4" Bolt throw: Cast alloy full 1" throw Latch throw: 5/8" (anti-friction) Case: High pressure cast Zamac, baked enamel finish Front: 1-1/4" x 8", Flat or 3° bevel Hubs: 9/32" on square steel, w/ security separator 	Grade 2 for Knobs & Levers Series 7 2-3/4" Backset Series 9 2-1/2" Backset		
		<ul style="list-style-type: none"> Backset: 2-1/2" Bolt throw: Cast alloy full 1" throw Latch throw: Solid brass 1/2" throw, reversible Case: High pressure cast Zamac, baked enamel finish Front: 1-1/16" x 7-5/8", Flat or 3° bevel Hubs: 9/32" on square steel, w/ security separator 			
MARKS #		FUNCTION	ANSI #	FINISH GROUPS	
KEYED SINGLE CYLINDER, NO DEADBOLT					
D	OFFICE / VESTIBULE			3, 32D	10, 10B, 32
DW	VESTIBULE			277	294
KEYED SINGLE CYLINDER, WITH DEADBOLT					
A	ENTRANCE	F08, F10		292	308
B	ENTRANCE	F21			
F	DORMITORY	F12			
FS	DORMITORY				
FW	DORMITORY	F13			
KEYED DOUBLE CYLINDER, WITH DEADBOLT					
AC	ENTRANCE	F35		322	339
C	STOREROOM	F14			
FA	DORMITORY	F11			
FX	DORMITORY	F33			
KEYLESS					
N	PASSAGE	F01		222	239
L	BATHROOM	F02		292	308
LF	PRIVACY	F19			
MORTISE LOCK BODIES ARE PACKED 6 PER CASE					



Mortise Parts, Trim

MORTISE DEADLOCKS

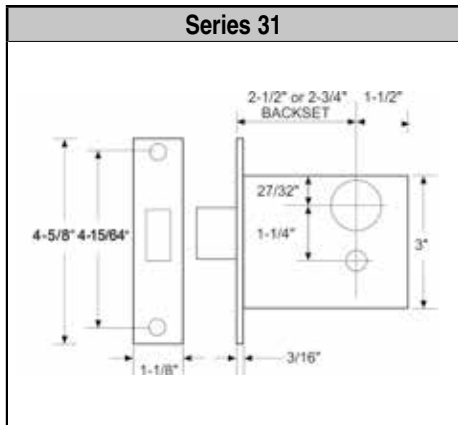
Mortise Parts, Trim



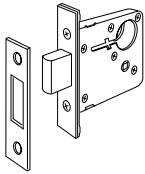

OPTIONS	CODE	PRICE
Security Strike: 4-7/8" x 1-1/4"	S4	11

Standard Features			Series 31 2-3/4" Backset	
 <ul style="list-style-type: none"> Backset: Series 31: 2-3/4" Bolt throw: 1" stainless steel with hardened roll pins Case: Stamped Steel, Grade 1 Front: 1-1/16" x 4-5/8" adjustable bevel Cylinder: Solid brass cylinder, 6-pin, "C" keyway, 2 keys Strike: #4035 (Included) 1-1/8" x 3-1/8" Strike: #4035-1 (Optional) 1-1/8" x 3-1/2" 				
			FINISH GROUPS	
MARKS #	FUNCTION	ANSI #	3, 26D	3E, 10, 10B, 26, 32
—	LOCK ONLY	—	181	204
K, 31K	CYLINDER x TURNPIECE	E06071	239	262
L, 31L	COMMUNICATING SINGLE CYL.	E06081	214	237
M, 31M	DOUBLE CYLINDER	E06061	242	271
S, 31S	CLASSROOM (Specify Handing)	E06091	271	295
X, 31X	TURNPIECE ONLY		191	212

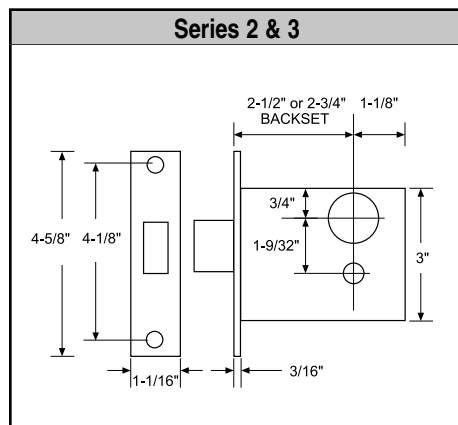
MORTISE LOCK BODIES ARE PACKED 6 PER CASE



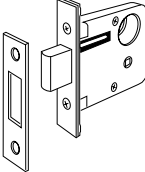

OPTIONS	CODE	PRICE
1-1/16" x 5-5/8" front	R	28

Standard Features			Series 2 • 2-1/2" Backset Series 3 • 2-3/4" Backset	
 <ul style="list-style-type: none"> Backset: Series 2: 2-1/2"; Series 3: 2-3/4" Bolt throw: 1" Case: High pressure cast Front: 1-1/16" x 4-5/8" flat or 3" bevel Cylinder: Solid brass cylinder, 6-pin, "C" keyway, 2 keys Strike: #4035 Included 				
			FINISH GROUPS	
MARKS #	FUNCTION	ANSI #	3, 26D	3E, 10, 10B, 26, 32
—	LOCK ONLY	—	127	149
K, 2K, 3K	CYLINDER x TURNPIECE	E06071	186	206
L, 2L, 3L	COMMUNICATING SINGLE CYL.	E06081	163	186
M, 2M, 3M	DOUBLE CYLINDER	E06061	196	217
S, 2S, 3S	CLASSROOM (Specify Handing)	E06091	215	241
X, 2X, 3X	TURNPIECE ONLY		137	157

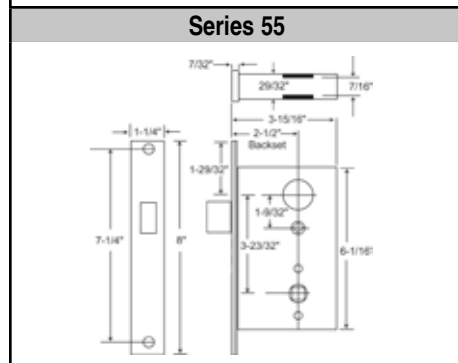
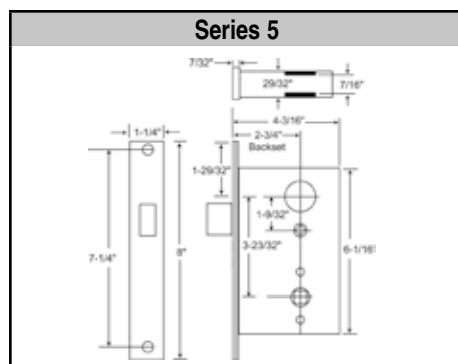
MORTISE LOCK BODIES ARE PACKED 6 PER CASE

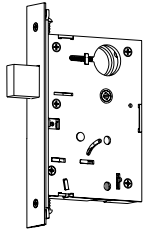

Standard Features			Series 5 • 2-3/4" Backset Series 55 • 2-1/2" Backset	
 <ul style="list-style-type: none"> Backset: Series 5: 2-3/4"; Series 55: 2-1/2" Bolt throw: Stainless steel full 1" throw Case: Stamped steel .090 thick, Zinc dichromate finish Front: 1-1/4" x 8" Adjustable bevel 				
			FINISH GROUPS	
MARKS #	FUNCTION	ANSI #	3, 26D	3E, 10, 10B, 32
T, 5T	DOUBLE CYLINDER	F16	364	377
P, 5P	CYLINDER x TURNPIECE	F17	334	356
S, 5S	SINGLE CYLINDER*	F18	308	332
SC, 5SC	CLASSROOM*	F29	356	377

MORTISE LOCK BODIES ARE PACKED 6 PER CASE
*NOTE: Specify handing on "S" and "SC" functions

OPTIONS	CODE	PRICE
1-1/16" x 7-5/8" front	T	27
1" x 7-3/4" front	V	27
1" x 1/16" x 8"	Q	27
Lead lined mortise lock	F1	325

MORTISE LOCKSET FUNCTIONS

ANSI #	TYPE	MARKS FUNCTION	ANSI #	TYPE	MARKS FUNCTION	ANSI #	TYPE	MARKS FUNCTION	ANSI #	TYPE	MARKS FUNCTION
F01	Non-Keyed	N	F10	Single Cylinder	A	F19	Non-Keyed	LF	F29	Deadbolt	SC
F02	Non-Keyed	L	F11	Double Cylinder	FA	F20	Single Cylinder	FD	F30	Double Cylinder	WW
F04	Single Cylinder	E	F12	Single Cylinder	F	F21	Single Cylinder	B	F31	Non-Keyed	EX
F05	Single Cylinder	J	F13	Single Cylinder	FW	F22	Non-Keyed	LJ	F32	Double Cylinder	GC
F06	Single Cylinder	JM	F14	Double Cylinder	C	F24	Double Cylinder	C	F33	Double Cylinder	FX
F06	Single Cylinder	JR	F15	Single Cylinder	H	F25	Double Cylinder	C	F34	Double Cylinder	FC
F07	Single Cylinder	EW	F16	Deadbolt	T	F25	Double Cylinder	SO	F35	Double Cylinder	AC
F08	Single Cylinder	A	F17	Deadbolt	P	F26	Single Cylinder	GL			
F09	Double Cylinder	G	F18	Deadbolt	S	F27	Auto Deadbolt	AD			

SINGLE CYLINDER FUNCTIONS

ANSI #	Cam	Strike	Marks Function	
			I/S	O/S
F04: OFFICE Latch by knob/lever either side except when outside knob/lever locked by stop-button in front; then by key outside. Auxiliary latch deadlocks latch. Inside always open.				
	2101	5036		E
F04: OFFICE Latch by knob/lever either side except when outside knob/lever locked by turn piece inside; then by key outside. Auxiliary latch deadlocks latch. Inside always open.				
	2105	5036		K
F05: CLASSROOM Latch by knob/lever either side except when outside knob/lever locked by key. When locked, latch bolt retracted by key. Inside always open. Auxiliary latch deadlocks latch.				
	2105	5036		J
F06: HOLDBACK "A" Latch by knob/lever either side except when outside knob/lever locked or unlocked by key. Auxiliary latch deadlocks latch. Inside always open. Inside knob/lever unlocks outside lever. Latch bolt can be locked in retracted position by locking inside hub. Can be used with blank outside trim.				
	2105	5036		JM
F06: HOLDBACK "B" Latch by knob/lever either side except when outside knob/lever locked or unlocked by key. Auxiliary latch deadlocks latch. Inside always open. Inside knob/lever will not unlock outside knob/lever. Latch bolt can be locked in retracted position by locking outside hub. Can not be used with blank outside trim.				
	2105	5036		JR
F07: STOREROOM Latch by knob/lever inside, key outside. Outside knob/lever always rigid. Auxiliary latch deadlocks latch. Inside always open.				
	2101	5036		EW
F08, F10: ENTRANCE Latch by knob/lever either side except when outside locked by stop-button; then by key outside, knob/lever inside. Deadbolt by key outside, turnpiece inside. Deadbolt deadlocks latch.				
	2102	9035		A
F12: DORMITORY Latch by knob/lever either side except when outside knob/lever locked by stop-button or projected deadbolt. Deadbolt by turnpiece inside. Inside knob/lever retracts latch and deadbolt simultaneously, leaving outside locked. Deadbolt deadlocks latch.				
	2102	9035		F
F13: DORMITORY Latch by knob/lever either side except when projected deadbolt locks outside knob/lever and deadlocks latch. Deadbolt and latch by key outside. Deadbolt by turnpiece inside. Inside knob/lever retracts latch and deadbolt simultaneously, automatically unlocking outside knob/lever.				
	2102	9035		FW
F15: HOTEL Inside knob/lever always free, outside rigid. Latch by knob/lever inside, key outside. (When deadbolt projected by turnpiece all keys are shut out except emergency key). Inside knob/lever retracts deadbolt and latch simultaneously. Auxiliary latch or deadbolt deadlocks latch. Indicator available.				
	2102	5035		H
F20: APARTMENT Latch by knob/lever either side except when outside locked by stop-button or projected deadbolt. Latch deadlocked by auxiliary latch or deadbolt. Deadbolt and latch by key outside. Deadbolt by turnpiece inside. Inside knob/lever retracts latch & deadbolt simultaneously, leaving outside locked.				
	2102	5035		FD

SINGLE CYLINDER FUNCTIONS

ANSI #	Cam	Strike	Marks Function	
			I/S	O/S
F21: ENTRANCE Latch by knob/lever either side. Deadbolt by key outside, turnpiece inside. Deadbolt deadlocks latch.				
	2102	9035		B
F26: INSTITUTIONAL PRIVACY Latch by knob/lever either side except when outside knob/lever locked by inside turn piece. Latch deadlocked by auxiliary latch. Key outside opens latch. When outside locked, inside knob/lever retracts latch, automatically unlocking outside knob/lever.				
	2101	5036		GL
F27: Auto Deadbolt Depressing auxiliary latch projects deadbolt and deadlocks latch. Remains locked even if auxiliary latch is extended. Inside knob/lever retracts both bolts simultaneously. When outside is locked, both bolts are retracted by override key with outside knob/lever.				
	2101	5035		AD
OFFICE VESTIBULE: Latch by knob/lever either side except when outside knob/lever locked by stop-button in front; then by key outside.				
	2101	9035		D
VESTIBULE: Latch by knob/lever inside, key outside. Outside knob/lever always rigid.				
	2101	9035		DW
DORMITORY: Latch by knob/lever inside. Outside knob/lever always rigid. Deadbolt and latch by key outside. Deadbolt by turnpiece inside. When deadbolt is projected, latch is deadlocked. Inside knob/lever retracts latch and deadbolt simultaneously.				
	2102	9035		FS
SPECIAL PRIVACY: Inside knob/lever always free, outside rigid. Latch by knob/lever inside, key outside. Deadbolt by turnpiece inside, emergency release outside. Inside knob/lever retracts deadbolt and latch simultaneously. Auxiliary latch deadlocks latch.				
	2102	5035		LH
STOREROOM: Latch by thumbpiece inside. Key outside.				
	2101	9035		DN
STOREROOM: Latch by thumbpiece or knob/lever inside. Key outside. Auxiliary latch deadlocks latch.				
	2101	5036		EN
ELECTRIFIED FUNCTIONS				
ELECTRICALLY LOCKED (Fail Safe): Outside always locked electrically. Open by key outside, switch or loss of power. Auxiliary latch deadlocks latch. Inside always open.				
	2101	5036		EL
ELECTRICALLY UNLOCKED (Fail Secure): Outside always locked until unlocked by key or electrically energized. Auxiliary latch deadlocks latch. Inside always open.				
	2101	5036		EU







Mortise Parts, Trim

MORTISE LOCKSET FUNCTIONS

DOUBLE CYLINDER FUNCTIONS				
ANSI #	Cam	Strike	Marks Function	
F09: ENTRANCE Latch by knob/lever either side except when outside knob/lever locked by key inside, latch retracted by key outside. Outside remains locked. Auxiliary latch deadlocks latch.	IS 2101 2106	5036	IS O/S	G
F11: DORMITORY Latch by knob/lever either side except when outside knob/lever locked by stop-button or projected deadbolt. Deadbolt by key either side. Inside knob/lever retracts latch and deadbolt simultaneously leaving outside locked. Deadbolt deadlocks latch.	IS 2102	9035		FA
F14: STOREROOM Latch by knob/lever either side. Deadbolt by key either side. Deadbolt deadlocks latch.	IS 2102	9035		C
F24: APARTMENT HANDLE Latch by thumbpiece either side except when outside is locked by key inside. When outside is locked, latch retracted by key outside or thumbpiece inside. Auxiliary latch deadlocks latch.	IS 2101 2106	5036		G
F25: STOREROOM "B" Body Latch by thumbpiece either side. Deadbolt by key either side.	IS 2102	9035		C
F25: STOREROOM Latch by thumbpiece either side except when outside thumbpiece locked by stop-button in front; then by key outside. Deadbolt by key both sides. Deadbolt deadlocks latch.	IS 2102	9035		SO
F30: INSTITUTION Both knob/levers rigid. Auxiliary latch deadlocks latch. Latch by key either side.	IS 2101	5036		WW
F32: INTRUDER LATCH BOLT Latch by knob/lever either side except when outside knob/lever is locked from inside or outside by key. Latch operated by key from inside or outside. Auxiliary latch, deadlocks latch. Inside always open.	IS 2105	5036		GC
CLASSROOM SECURITY Latch bolt retracted by knob/lever from either side unless outside is locked by key from either side. Auxiliary latch deadlocks latch bolt when door is locked. Inside knob/lever is always free for immediate egress.	IS 2101	5036		GG
CLASSROOM SECURITY Latch by lever either side except when outside lever is locked or unlocked by key from either side. With outside locked, exterior key will retract the latch allowing the outside to remain locked. Inside always free for egress. Auxiliary latch deadlocks latch.	IS 2101 2105	5036		GJ
CLASSROOM SECURITY w/HOLDBACK Latch bolt retracted by knob/lever from either side unless outside is locked by key from either side. When locked, latch bolt retracted by key outside or knob/lever inside. Auxiliary latch deadlocks latch bolt when door is locked. Depress inside knob/lever and turn key 360° for holdback feature. Inside knob/lever always free for immediate egress.	IS 2101 2105	5036		GR
F33: DORMITORY Latch by knob/lever either side except when projected deadbolt locks outside knob/lever and deadlocks latch. Deadbolt and latch by key either side. Inside knob/lever retracts latch and deadbolt simultaneously, automatically unlocking outside knob/lever.	IS 2102	9035		FX
F33: DORMITORY Latch by knob/lever either side except when projected deadbolt locks outside knob/lever and deadlocks latch. Deadbolt and latch by key either side. Inside knob/lever retracts latch and deadbolt simultaneously, automatically unlocking outside knob/lever.	IS 2102	5035		FC

DOUBLE CYLINDER FUNCTIONS (Con't)				
ANSI #	Cam	Strike	Marks Function	
F35: STORE DOOR Latch by knob/lever either side except when outside knob/lever locked by stop-button in front; then by key outside. Deadbolt by key either side. Deadbolt deadlocks latch.	IS 2102	9035		AC
NON-KEYED FUNCTIONS				
ANSI #		Strike	Marks Function	
F01: PASSAGE Latch by knob/lever either side.		9035	IS O/S	N
F02: BATHROOM* Latch by knob/lever either side. Deadbolt by turnpiece inside. Deadbolt deadlocks latch. To unlock from outside, remove emergency button, insert emergency key in access hole and turn. Optional coinkey assembly available.		9035		L
F19: PRIVACY* Latch by knob/lever either side except when projected deadbolt locks outside knob/lever and deadlocks latch. Deadbolt by turnpiece inside. Inside knob/lever retracts latch and deadbolt simultaneously, automatically unlocking outside knob/lever. To unlock from outside, remove emergency button, insert emergency key in access hole and turn. Optional coinkey assembly available.		9035		LF
F22: PRIVACY Latch by knob/lever either side except when outside knob/lever is locked by inside turnpiece. Turning inside knob/lever or closing door unlocks outside lever. To unlock from outside, remove emergency button, insert emergency key in access hole and turn. Optional coinkey assembly available.		9035		LJ
F31: EXIT Latch by knob/lever inside, no trim outside. Auxiliary latch deadlocks latch. None removable blank trim: F26 option		5036		EX
DEADBOLT FUNCTIONS				
	IS	Cam		
F16: DEADLOCK Deadbolt by key either side.	2102	2102	9035	T
F17: DEADLOCK Deadbolt by key outside and turnpiece inside.		2102	9035	P
F18: DEADLOCK Deadbolt by key one side only.		2102	9035	S
F29: DEADLOCK Deadbolt by key outside. Inside turnpiece will retract but will not project deadbolt.		2102	9035	SC
DEADLOCK Latch by knob/lever either side. Deadbolt by key either side; latch remained unlocked at all times. Note: With this function deadbolt protrusion is 13/16		2102	9035	CT
DEADLOCK FUNCTIONS				
E06072: CYLINDER BY TURNPIECE Deadbolt by inside turnpiece or outside key.		2102		K
E06082: COMMUNICATING SINGLE CYLINDER* Deadbolt by key from one side only.		2102		L
E06062: DOUBLE CYLINDER Deadbolt by key either side.		2102		M
E06092: CLASSROOM Deadbolt by outside key. Turnpiece will retract but not project deadbolt.		2102		S
TURNPIECE Deadbolt by inside turnpiece.		2102		X
*PRIVACY INDICATOR AVAILABLE				

MORTISE LOCKSET PARTS RK, RL

ROSES	RR: 2-9/16" dia.	RW: 2-9/16" dia.	RQ: 2-1/4" dia.	RS: 2-1/4" dia.	RX: 2-1/2" sq.	*RK: 2-1/2" sq.	*RL: 2-1/2" sq.
					 Wrought	 Forged	 Forged

Knob / Rose Kits

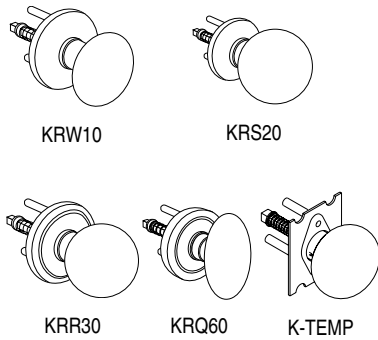

ROSE WITH RING	PLAIN ROSE	SMALL ROSE W/RING	SMALL ROSE	DESCRIPTION	FINISH GROUPS						ROSE RK*
					3	3E	10, 10B	15	26	32D	
KRR10	KRW10	KRQ10	KRS10	Round knob/ball assembly	195	—	—	—	—	195	+106
KRR20	KRW20	KRQ20	KRS20	Ball knob/ball assembly							
KRR30	KRW30	KRQ30	KRS30	Ball knob/ball assembly	—	212	251	284	284	—	
KRR60	KRW60	KRQ60	KRS60	Eclipse knob/ball assembly							
NO FINISH											
K-TEMP				Temporary Trim	66						
K-TEMP-G3				Temporary Trim less cyl	50						

Complete knob/rose assemblies both sides (includes spindles).

Lever / Rose Kits

* Specify handing

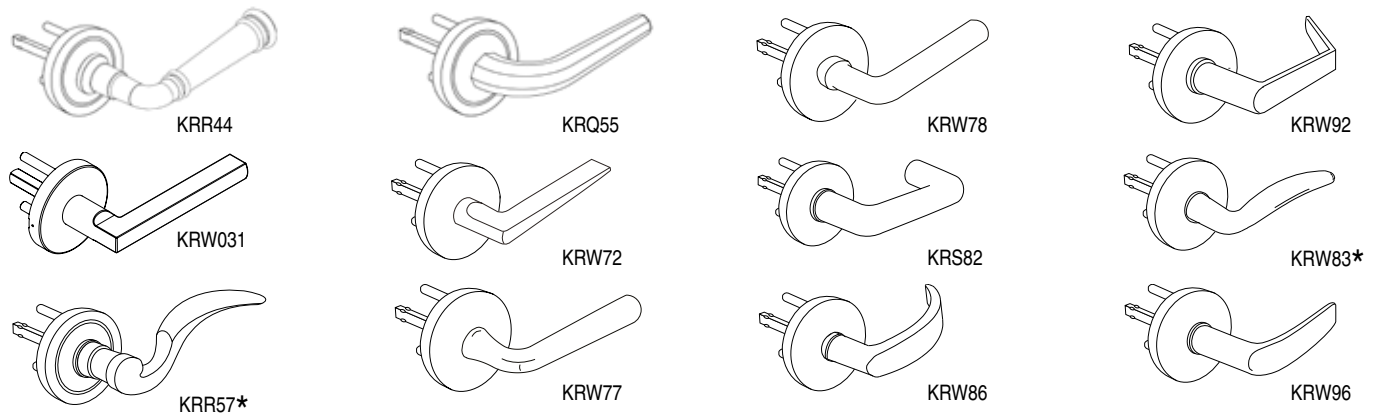

PART #		DESCRIPTION	FINISH GROUPS						ROSE RK*	ROSE RL*
ROSE WITH RING RR	SMALL ROSE WITH RING RQ		3E	4	26D	15	10, 10B, 26	32D		
		Complete lever/rose assemblies both sides (includes spindles).								
KRR44	KRQ44	Stanhope lever/rose kit	208	312	312	312	312	—	+106 FOR ALL FINISHES	+31 FOR ALL FINISHES
KRR57	KRQ57	Monaco lever/rose kit	208	312	312	312	—	—		
KRR55	KRQ55	Brompton lever/rose kit	208	312	312	312	—	—		
		Complete lever/rose assemblies both sides (includes spindles).								
KRW031	KRS031	Copa lever/rose kit	312	312	—	312	312	—	+106 FOR ALL FINISHES	31 FOR ALL FINISHES
KRW72	KRS72	Towne lever/rose kit	312	312	312	312	353	—		
KRW77	KRS77	Maxwell lever/rose kit	312	312	312	312	353	332		
KRW78	KRS78	Omni lever/rose kit	312	312	312	312	353	332		
KRW82	KRS82	Plaza lever/rose kit	312	312	312	312	353	332		
KRW83	KRS83	Dayton lever/rose kit	312	312	312	312	353	332		
KRW86	KRS86	Crescent lever/rose kit	312	312	312	312	353	—		
KRW92	KRS92	American lever/rose kit	312	312	312	312	353	332		
KRW96	KRS96	Titan lever/rose kit	312	312	312	312	353	332		

FOR ADDITIONAL DESIGNS, ASK FOR THE CUSTOM LOCK DIVISION CATALOG OR VISIT OUR WEBSITE @ WWW.MARKSUSA.COM

1-800-645-9445 • Fax 631-225-6136 • ©2018 MARKS USA

MORTISE LOCKSET PARTS

Dummy Cylinder, Collars & Turnpieces

Mortise Parts, Trim

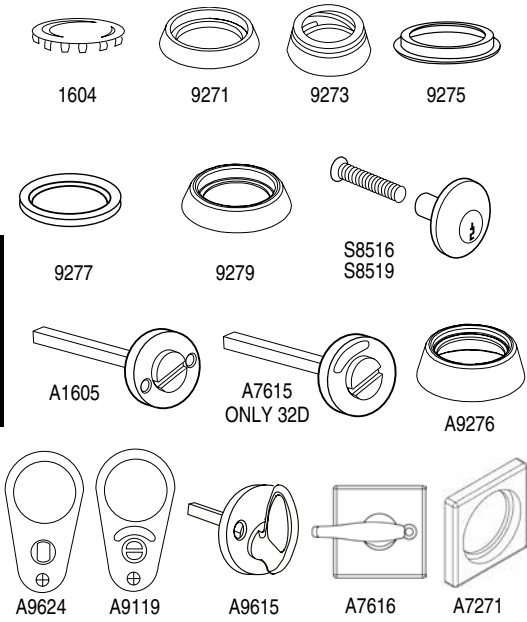

PART #	DESCRIPTION	FINISH GROUPS					
		3E	3, 26D	4	10, 10B, 26	32	32D
1604	Emergency hole cover	—	9	—	—	—	—
9271	Tapered collar, solid brass, 5/16" high	31	23	—	23	27	23
9273	Spring collar, 7/16" high	—	14	—	—	—	—
9275	Mortise spacer, wrought brass, 1/8" high	—	8	—	—	—	—
9277	Plastic spacer ring, 1/16"	6	—	—	—	—	—
9279	Tapered collar, wrought brass, 3/8" high	21	16	—	21	18	16
S8516	Dummy cylinder, inside	41	41	—	41	—	—
S8519	Dummy cylinder, outside	41	41	—	41	—	—
A1605	Emergency coinkey	69	63	63	63	—	—
A7271	Square cylinder collar, 1-3/4" x 5/16"	42	36	—	36	36	36
A7615	Occupancy indicator	—	—	—	—	—	52
A7616	Square Turnpiece Rose	75	57	75	66	66	66
A9276	Collar, wrought brass w/insert, 1/2" high	—	21	—	29	29	29
A9624	Hotel indicator plate ass'y for rose trim	89	66	—	71	—	—
A9119	Occupancy indicator plate ass'y for rose trim	—	102	—	—	—	—
A9615	Turnpiece	64	46	64	54	64	54

Strikes

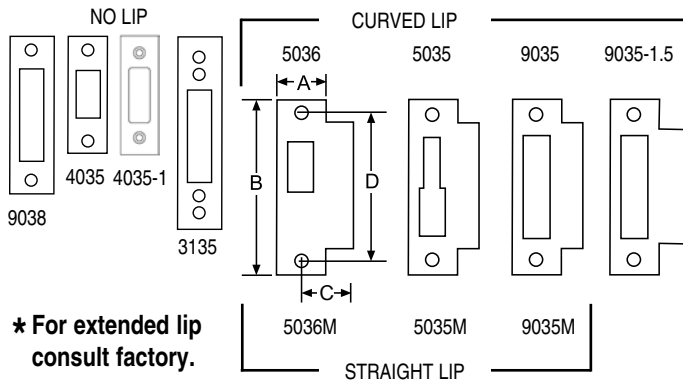

* For extended lip consult factory.

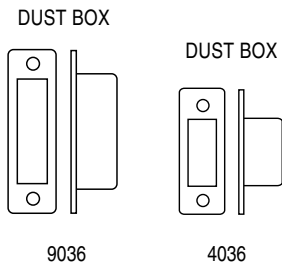

TYPE	PART #	A	B	C*	D	FINISH GROUPS	
						S3	3, 10, 10B, 32, 32D
No Lip	4035	1-1/8"	3-1/8"	—	—	8	16
	4035-1	1-1/8"	3-1/2"	3-1/2"	2-1/2"		
	9038	1-1/8"	4-7/8"	—	2-1/2"	9	—
	3135	1-1/4"	4-7/8"	—	—	—	21
Curved Lip	5035 †	1-1/4"	4-7/8"	1-1/4"	4-1/8"	—	23
	5036 †	1-1/4"	4-7/8"	1-1/4"	4-1/8"	—	23
	9035	1-1/4"	4-7/8"	1-1/4"	4-1/8"	8	23
	9035-1.5	1-1/4"	4-7/8"	1-1/2"	4-1/8"	—	36
Straight Lip	5035M †	1-1/4"	4-7/8"	7/8"	4-1/8"	—	28
	5036M †	1-1/4"	4-7/8"	7/8"	4-1/8"	—	28
	9035M	1-1/4"	4-7/8"	7/8"	4-1/8"	—	28
Dust Box	9036	Dust box for 9038 strike, plastic				8	—
	4036	Dust box for 4035 strike, plastic				6	—

† Specify handing.
Extended lip strikes from 1-1/4" - 2", Add \$16.

*Extended lip strikes over 2", consult factory.

Spindles

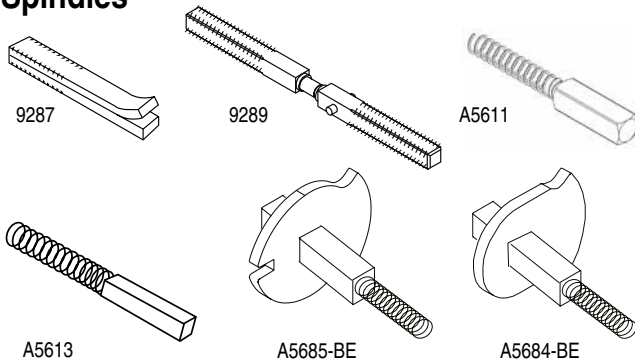

PART #	DESCRIPTION	
9287	2-1/2" LONG, HOOK SPINDLE, 2 PIECE	14
9289	4-3/4" LONG, SWIVEL SPINDLE	14
A5611	SPINDLE/SPRING ASSEMBLY FOR LEVERS, 5/16", 1" L	14
A5613	SPINDLE/SPRING ASSEMBLY FOR LEVERS, 5/16", 1-5/8" L	14
A5685-BE	CAM/SPINDLE SPRING ASSEMBLY EXTERIOR	23
A5684-BE	CAM/SPINDLE SPRING ASSEMBLY INTERIOR	23

TRIM LOCK PARTS

How to Order Example for Knob & Lever Assemblies							
DV	02	-	30	/	15	-	G3
1. <i>Plate/Rose Design</i>	2. <i>Trim Description</i>	<i>Dash</i>	3. <i>Knob/Lever Design</i>	<i>Slash</i>	4. <i>Finish</i>	<i>Dash</i>	5. <i>Options</i>

PLATE/ROSE DESIGN	TRIM DESCRIPTION	KNOB DESIGN	FINISH	OPTIONS
<input type="checkbox"/> BA <input type="checkbox"/> RR <input type="checkbox"/> CL <input type="checkbox"/> RW <input type="checkbox"/> CP <input type="checkbox"/> RQ <input type="checkbox"/> CR <input type="checkbox"/> RS <input type="checkbox"/> DR <input type="checkbox"/> RX <input type="checkbox"/> DV <input type="checkbox"/> GC <input type="checkbox"/> MA <input type="checkbox"/> NY <input type="checkbox"/> NS <input type="checkbox"/> TN	<input type="checkbox"/> 01 Outside knob/lever/cylinder <input type="checkbox"/> 02 Inside knob/lever/turnpiece <input type="checkbox"/> 03 Inside knob/lever/cylinder <input type="checkbox"/> 04 Inside knob/lever only <input type="checkbox"/> 05 Outside cylinder only <input type="checkbox"/> 06 Outside knob/lever /emergency coinkey <input type="checkbox"/> 07 Outside hotel <input type="checkbox"/> 08 Outside knob/lever only	<input type="checkbox"/> 10 <input type="checkbox"/> 20 <input type="checkbox"/> 30 <input type="checkbox"/> 60 LEVER DESIGN <input type="checkbox"/> 44 <input type="checkbox"/> 82 <input type="checkbox"/> 55 <input type="checkbox"/> 83 <input type="checkbox"/> 57 <input type="checkbox"/> 86 <input type="checkbox"/> 72 <input type="checkbox"/> 92 <input type="checkbox"/> 77 <input type="checkbox"/> 96 <input type="checkbox"/> 78 <input type="checkbox"/> 031	<input type="checkbox"/> 3 <input type="checkbox"/> 3E <input type="checkbox"/> 4 <input type="checkbox"/> 10 <input type="checkbox"/> 10B <input type="checkbox"/> 15 <input type="checkbox"/> 26 <input type="checkbox"/> 26D <input type="checkbox"/> 32D <input type="checkbox"/> Special	<hr/> <hr/> <hr/> <hr/> <hr/> <hr/> <hr/> <hr/> Specify <ul style="list-style-type: none"> • Keying • Handing • Door Thickness







Mortise Parts, Trim





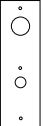



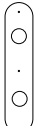
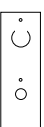

How to Order Example for Handle Assemblies				
CR41-39/15	/	15	-	G3
1. <i>Handle Assembly Design</i>	<i>Slash</i>	2. <i>Finish</i>	<i>Dash</i>	3. <i>Options</i>

PLATE/ROSE DESIGN	FINISH	OPTIONS
<input type="checkbox"/> CR41-39 Crown <input type="checkbox"/> TN41-39 Towne	<input type="checkbox"/> 3E <input type="checkbox"/> 15 <input type="checkbox"/> Special	<hr/> <hr/> <hr/> <hr/> <hr/> <hr/> <hr/> <hr/> Specify <ul style="list-style-type: none"> • Keying • Handing • Door Thickness

TRIM LOCK PARTS

















Mortise Parts, Trim

PLATE/ROSE DESIGN	3	3E	10	10B	15	26D	32D
BARRIER BA 	—	—	—	—	—	—	229
CLASSIC CL 	80	—	80	80	—	81	94
CAPITOL CP 	129	—	127	127	—	—	118
CROWN CR 	163	—	186	186	163	163	163
DRAKE DR 	197	—	215	215	197	197	204
DAVOS DV 	266	—	289	289	266	266	—
MADISON MA 	—	214	—	—	250	—	—
SCHOOL LA 	—	—	—	—	—	—	186

PLATE/ROSE DESIGN	3	3E	10	10B	15	26D	32D
NEW YORKER NY 10" PLATE 	46	—	—	—	—	56	—
NEW YORKER NS 7" PLATE 	34	—	—	—	—	46	—
TOWNE TN 	—	214	—	—	251	—	—
2-9/16" DIA. ROSE W-RING RR 	108	141	130	130	119	108	108
2-9/16" DIA. PLAIN ROSE RW 	108	141	130	130	119	108	108
2-1/4" DIA. SMALL ROSE W-RING RQ 	108	141	130	130	119	108	108
2-1/4" DIA. SMALL ROSE RS 	108	141	130	130	119	108	108
2-1/2" SQ. SQUARE ROSE RX 	108	141	130	130	119	108	108
2-1/2" SQ. SQUARE ROSE RK 	OUTSIDE	181	212	201	201	191	181
	INSIDE	192	223	213	213	202	192
SQUARE TURNPIECE ROSE A7616 	59	75	66	66	66	66	66
2-1/2" SQ. SQUARE ROSE RL 	192	223	213	213	202	192	192

TRIM LOCK PARTS

Knob / Lever Design

KNOB/LEVER	FINISH GROUPS									
	3	3E	4	10	10B	15	26	26D	32D	
ROUND KNOB  10	96	—	—	117	117	—	117	117	96	
BALL KNOB  20	96	—	—	117	117	—	117	117	96	
BALL KNOB  30	—	163	—	117	—	205	205	—	—	
ECLIPSE KNOB  60	—	163	—	—	—	205	205	—	—	
STANHOPE LEVER  44	—	196	196	216	216	196	216	196	192	
COPA LEVER  031	163	196	196	216	216	196	216	196	—	
MONACO LEVER  57	—	196	196	216	216	196	216	196	—	
BROMPTON LEVER  55	—	196	196	216	216	196	216	196	—	
TOWNE LEVER  72	163	196	196	216	216	196	216	196	—	
MAXWELL LEVER  77	163	196	196	216	216	196	216	196	192	
OMNI LEVER  78	163	196	196	216	216	196	216	196	—	
PLAZA LEVER  82	163	196	196	216	216	196	216	196	192	
DAYTON LEVER  83	163	196	196	216	216	196	216	196	196	
CRESCENT LEVER  86	163	196	196	216	216	196	216	196	192	
AMERICAN LEVER  92	163	196	196	216	216	196	216	196	192	
TITAN LEVER  96	163	196	196	216	216	196	216	196	192	

Mortise Parts, Trim

TRIM LOCK PARTS

Handle Design

CR41-39 Crown

16" x 3-7/32" x 11/16"

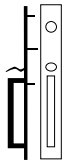

3E 476

15 534

TN41-39 Towne

16-3/8" x 2-1/4" x 3/8"

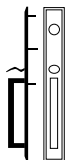

3E 476

15 534

Mortise Parts, Trim

MORTISE DOOR ACCESSORIES

Recess Stainless Steel Door Pulls

TP015



TP046



MARKS #	PRICE
TP015	32
TP046	32

How To ORDER CYLINDRICAL LOCKSETS

How To Order Example for Cylindrical Locksets

195	N	/	26D	—	G3
<i>1. Lockset Series</i>	<i>2. Marks Function</i>	<i>Slash</i>	<i>3. Finish</i>	<i>Dash</i>	<i>4. Options</i>

1	SERIES
Cylindrical Locksets:	110, 110R, 210, 210R, 180, 180R, 280, 280R, 175, 175R, 195, 195R, 295, 295R, 495, 495R

2	CYLINDRICAL FUNCTIONS		
MARKS #	FUNCTION	ANSI	#
N	—	PASSAGE	F75
L	—	PRIVACY	F76
LK	—	HOSPITAL/PRIVACY	F76 MOD.
P	—	PATIO	F77
DC	RDC	COMMUNICATING	F80
A	RA	ENTRY	F81
B	RB	ENTRY	F82A
AQ	—	EXIT	F83
S	RS	CLASSROOM	F84
F	RF	STOREROOM	F86
DW	RDW	INSTITUTION	F87
DA	RDA	VESTIBULE	F88
FQ	—	EXIT	F89
T	RT	CORRIDOR	F90
TK	—	HOSPITAL/PRIVACY	F90 MOD.
GB	RGB	STORE DOOR (95 SERIES ONLY)	F91
BS	—	SERVICE STATION LOCK	F92
H	—	HOTEL	F93
AB	RAB	ENTRANCE	F109
DB	RDB	CLASSRM. INTRUDER	F110
NB	—	COMMUNICATING PASSAGE	F111
FB	—	COMMUNICATING STOREROOM	F112
SB	RSB	COMMUNICATING CLASSROOM	F113
FEL	RFEL	ELECTRONICALLY LOCKED	
FEU	RFEU	ELECTRONICALLY UNLOCKED	
DUMMY TRIM			
DO		DUMMY TRIM OUTSIDE	
DT		FULL DUMMY	

3	FINISH	
MARKS #	ANSI #	FINISH
US 3	605	Polished Brass, Clear Coated
US 4	606, 606E	Satin Brass, Clear Coated
US 10	612E	Satin Bronze, Clear Coated
US 10B	613E	Dark Bronze, Clear Coated
US 26	625	Polished Chrome, Plated
US 26D	626	Satin Chrome, Plated
US 32	629	Polished Stainless Steel
US 32D	630	Satin Stainless Steel

4	OPTIONS		
TRIM MODIFICATIONS	CODE	PRICE	PRICE
Tactile knob/lever, coated ext. only	A1		60
Tactile knob/lever, knurled	A4		60
Large rose 3-1/8" diameter	A8		11
Tactile knob/lever, coated int. & ext.	A18		122
DOOR THICKNESS	CODE	PRICE	PRICE
2" (50 mm)	D1		NC
2-1/4" (57mm)	D2		75
Over 2-3/8" - 4"	D9		648
LATCH	CODE	PRICE	PRICE
2-3/4" backset, 1-1/8" x 2-1/4" face	E4		NC
2-3/8" backset, 1" x 2-1/4" face	E6		NC
2-3/4" backset, 9/16" throw, Gr. 1, UL Listed	E7		47
5" backset, 9/16" throw, Gr. 1	E9		47
3-3/4" backset, 9/16" throw, Gr. 1	E10		47
2-3/8" backset, 1-1/8" x 2-1/4" face	E11		12
2-3/4" backset, 1" x 2-1/4" face	E12		12
TRIM CHANGES	CODE	PRICE	PRICE
Yale conventional	F7		23
Sargent conventional cylinder	F8		23
Corbin conventional cylinder	F9		23
Corbin 6 pin IC core	F12		34
Corbin 7 pin IC core	F13		34
Yale 6 pin IC core	F14		23
Yale 7 pin IC core	F15		23
Schlage 6 pin IC core	F19		23
Sargent IC core	F20		23
Medeco IC core large format	F21		23
CYLINDER	CODE	PRICE	PRICE
Special optional keyway	G2		37
Less cylinder	G3		Deduct 15
STRIKE	CODE	PRICE	PRICE
4-7/8" ASA strike	S1		13
2-3/4" "T" strike	S3		NC

80 LINE GRADE 1 CYLINDRICAL KNOBSETS

BHMA CERTIFIED		ANSI-A156.2 • Grade 1 3 Hour Fire Rating		Series 180/180R • 2-3/4" Backset Series 280/280R • 2-3/4" Backset	
80 Series Knobsets Shown Below				Standard Features	
				<ul style="list-style-type: none"> • Backset: 2-3/4" • Latch #1834, Front: 1-1/8" x 2-1/4" • Throw: 9/16"; Stainless steel nose • Knobs: 2-1/4" dia. (180) round; 2-3/16" dia. (280) ball • Roses: Adjustable both sides; Steel reinforced 2-3/4" dia. • Strike: #1135, 4-7/8" ASA curved lip strike • Door thickness: 1-5/8" to 1-7/8" • Cylinder: MARKS "C" keyway, 6 pin w/ 2 keys 	
MARKS #		FUNCTION	ANSI #	FINISH GROUPS	
COMM. CYL.	IC CORE CYL.*			3 ❖, 32D	10, 10B, 32
N	—	PASSAGE	F75	434	473
L	—	PRIVACY	F76	438	477
P	—	PATIO	F77	438	477
DC	RDC ❖	COMMUNICATING	F80	508	547
A	RA ❖	ENTRY	F81	461	500
B	RB ❖	ENTRY	F82A	461	500
AB	RAB ❖	ENTRY	F109	461	500
AQ	—	EXIT	F83	449	488
S	RS ❖	CLASSROOM	F84	461	500
F	RF ❖	STOREROOM	F86	461	500
DW	RDW ❖	INSTITUTION	F87	508	547
DA	RDA ❖	VESTIBULE	F88	508	547
FQ	—	EXIT	F89	449	488
TK	—	HOSPITAL/PRIVACY MOD.	F90	473	511
BS	RBS ❖	SERVICE STATION LOCK	F92	474	512
DO	—	DUMMY TRIM OUTSIDE	—	262	282
DT	—	FULL DUMMY TRIM	—	361	400
NB	—	COMMUNICATING PASSAGE	F111	398	418
FB	RFB ❖	COMMUNICATING STOREROOM	F112	457	477
SB	RSB ❖	COMMUNICATING CLASSROOM	F113	457	477

KNOBS ARE PACKED 12 PER CASE

NOTE: Split designs and/or finishes are priced at the highest design and/or finish • Special finishes, consult factory
 • IC Core Models: Tailpieces included, core not included
 ❖ IC Core Models in US3 Finish: Add \$42.00 to list price

OPTIONS	CODE	PRICE
For 2" doors	D1	NC
For 2-1/4" doors	D2	75
2-3/8" backset, 1" x 2-1/4" face	E6	NC
5" backset, 9/16" throw, Gr. 1	E9	47
3-3/4" backset, 9/16" throw, Gr. 1	E10	47
Less cylinder	G3	Deduct 15
2-3/4" "T" strike	S3	NC

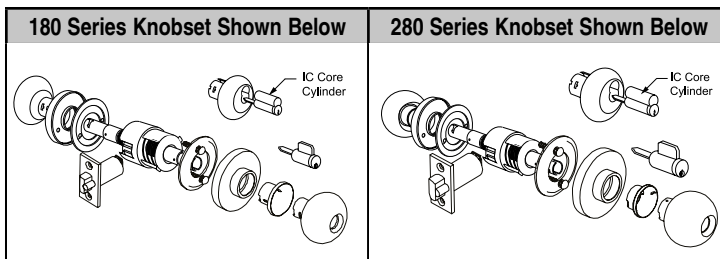



★Standard & HI-SECURITY™ IC Core Models:

Interchangeable Core models for 6 or 7 pin cores (not included).

Accepts: Marks, Marks HI-SECURITY™, Medeco®, KeyMark™, Falcon, Schlage® small format & Best®. **IC Core Tailpieces ARE Included.**

10 LINE GRADE 2 CYLINDRICAL KNOBSETS

BHMA CERTIFIED		ANSI-A156.2 • Grade 2 Plus 3 Hour Fire Rating		Series 110/110R • 2-3/8" Backset Series 210/210R • 2-3/8" Backset		
10 Series Knobsets Shown Below				Standard Features		
 				<ul style="list-style-type: none"> • Backset: 2-3/8" • Latch #1138, Front: 1" x 2-1/4"; Throw: 1/2"; Stainless steel nose • Knobs: 2-1/4" dia. (110) round; 2-3/16" dia. (210) ball • Roses: Adjustable both sides; Steel reinforced 2-3/4" dia. • Strike: #1136, 2-3/4" "T" strike • Door thickness: 1-5/8" to 1-7/8" • Cylinder: MARKS "C" keyway, 6 pin w/ 2 keys 		
MARKS #			FUNCTION	ANSI #	FINISH GROUPS	
COMM. CYL.	IC CORE CYL.*	3❖, 32D			10, 10B, 32	
N	—	PASSAGE	F75	147	187	
L	—	PRIVACY	F76	176	215	
P	—	PATIO	F77	178	217	
DC	RDC ❖	COMMUNICATING	F80	235	275	
A	RA ❖	ENTRY	F81	208	247	
B	RB ❖	ENTRY	F82A	208	247	
AB	RAB ❖	ENTRY	F109	208	247	
AQ	—	EXIT	F83	194	233	
S	RS ❖	CLASSROOM	F84	208	247	
F	RF ❖	STOREROOM	F86	208	247	
DW	RDW ❖	INSTITUTION	F87	236	276	
DA	RDA ❖	VESTIBULE	F88	236	276	
FQ	—	EXIT	F89	194	233	
DO	—	DUMMY TRIM OUTSIDE	—	153	173	
DT	—	FULL DUMMY TRIM	—	161	199	
NB	—	COMMUNICATING PASSAGE	F111	157	177	
FB	RFB ❖	COMMUNICATING STOREROOM	F112	220	244	
SB	RSB ❖	COMMUNICATING CLASSROOM	F113	220	244	

KNOBS ARE PACKED 12 PER CASE

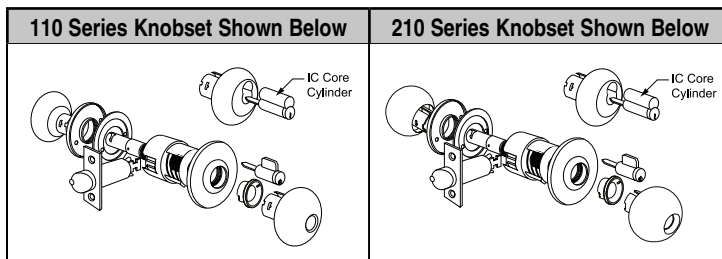

NOTE: Split designs and/or finishes are priced at the highest design and/or finish • Special finishes, consult factory
 • IC Core Models: Tailpieces included, core not included
 ❖ IC Core Models in US3 Finish: Add \$42.00 to list price

OPTIONS	CODE	PRICE
For 2" doors	D1	NC
For 2-1/4" doors	D2	75
2-3/4" backset, 1-1/8" x 2-1/4" face	E4	NC
2-3/4" backset, 9/16" throw, Gr. 1, UL Listed	E7	47
Solid latch for electric strike	E9	47
3-3/4" backset, 9/16" throw, Gr. 1	E10	47
Less cylinder	G3	Deduct 15
4-7/8" ASA strike with curved lip	S1	13



★ **Standard & HI-SECURITY™ IC Core Models:** 
 Interchangeable Core models for 6 or 7 pin cores (not included).
Accepts: Marks, Marks HI-SECURITY™, Medeco®, KeyMark™, Falcon, Schlage® small format & Best®. **IC Core Tailpieces ARE Included.**

95 LINE GRADE 1 CYLINDRICAL SURVIVOR LEVERSETS

BHMA CERTIFIED			ANSI-A156.2 • Grade 1 3 Hour Fire Rating		SURVIVOR SERIES Series 195/195R, 295/295R, 495/495R • 2-3/4" Backset	
95 Series Leversets Shown Below				Standard Features		
				<ul style="list-style-type: none"> • Backset 2-3/4" • Latch #1834, Front: 1-1/8" x 2-1/4"; Throw: 9/16"; Stainless steel nose • Levers: Solid cast Zamac; w/ 1/2" return (except 395 & 495) • Roses: Thru-bolted, 3-7/16" dia., spring loaded 2-#10 thru-bolts • Strike: #1135, 4-7/8" ASA curved lip strike • Door thickness: 1-5/8" to 1-7/8"; For 1-3/8" door use K1904 spacer • Cylinder: MARKS "C" keyway, 6 pin w/ 2 keys 		
MARKS #		FUNCTION	ANSI #	FINISH GROUPS		
COMM. CYL.	IC CORE CYL.*			3, 26D	4, 10, 10B, 26	
N	—	PASSAGE	F75	416	496	
L	—	PRIVACY	F76	439	524	
LK	—	HOSPITAL/PRIVACY	F76 MOD.	468	551	
P	—	PATIO	F77	434	518	
DC	RDC	COMMUNICATING	F80	504	585	
A	RA	ENTRY	F81	457	541	
B	RB	ENTRY	F82A	457	541	
AB	RAB	ENTRY	F109	457	541	
AQ	—	EXIT	F83	444	529	
S	RS	CLASSROOM	F84	457	541	
F	RF	STOREROOM	F86	457	541	
DW	RDW	INSTITUTION	F87	504	585	
DA	RDA	VESTIBULE	F88	504	585	
FQ	—	EXIT	F89	444	529	
T	RT	CORRIDOR	F90	468	551	
TK	—	HOSPITAL/PRIVACY	F90 MOD.	434	518	
GB	RGB	STORE DOOR	F91	621	678	
BS	RBS	SERVICE STATION LOCK	F92	468	551	
H	—	HOTEL	F93	515	596	
DB	RDB	CLASSROOM INTRUDER	F110	555	640	
DO	—	DUMMY TRIM OUTSIDE	—	258	340	
DT	—	FULL DUMMY TRIM	—	369	452	
NB	—	COMMUNICATING PASSAGE	F111	392	474	
FB	RFB	COMMUNICATING STOREROOM	F112	461	534	
SB	RSB	COMMUNICATING CLASSROOM	F113	461	534	
FEL	RFEL	ELECTRICALLY LOCKED*	—	668	752	
FEU	RFEU	ELECTRICALLY UNLOCKED*	—	668	752	

Marks USA Antimicrobial Finish Available - Option Code: AM - Add \$40

LEVERS ARE PACKED 6 PER CASE

NOTE: Split designs and/or finishes are priced at the highest design and/or finish • Special finishes, consult factory

*ELECTRIFIED FUNCTIONS: 100% Duty Cycle 24V AC/DC, supplied with bridge rectifier : EU - 210 ma; EL - 125 ma

• IC Core Models: Tailpieces included, core not included

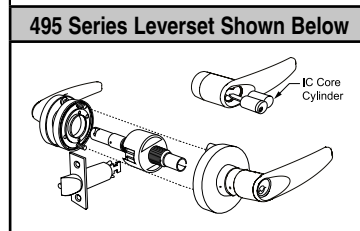
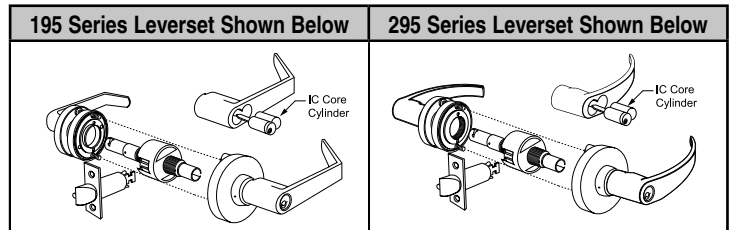

OPTIONS	CODE	PRICE - 195	295	495
For 2" doors	D1	NC	NC	NC
For 2-1/4" doors	D2	75	75	Call
Over 2-1/4" - 4" thickness	D9	648	648	648
2-3/8" backset, 1" x 2-1/4" face	E6	NC	NC	NC
5" backset, 9/16" throw, Gr. 1	E9	47	47	47
3-3/4" backset, 9/16" throw, Gr. 1	E10	47	47	47
Less cylinder	G3	Deduct 15	-15	-15
2-3/4" "T" strike	S3	NC	NC	NC
AMERICAN LEVER ONLY Accepts:				
Yale conventional cylinder	F7	23	23	—
Sargent conventional cylinder	F8	23	23	—
Corbin conventional cylinder	F9	23	23	—
Corbin 6 pin IC core	F12	34	34	—
Corbin 7 pin IC core	F13	34	—	—
Yale 6 pin IC core	F14	23	23	—
Yale 7 pin IC core	F15	23	—	—
Schlage 6 pin IC core	F19	23	23	—
Sargent IC core	F20	23	23	—
AMERICAN & CRESCENT LEVER ONLY Accepts:				
Medeco IC core large format	F21	23	23	—



★ **Standard & HI-SECURITY™ IC Core Models:** Interchangeable Core models for 6 or 7 pin cores (not included). **Accepts:** Marks, Marks HI-SECURITY™, Medeco®, KeyMark™, Falcon, Schlage® small format & Best®. **IC Core Tailpieces ARE Included.**



75 LINE GRADE 2 CYLINDRICAL SURVIVOR LEVERSETS

BHMA CERTIFIED			ANSI-A156.2 • Grade 2 Plus 3 Hour Fire Rating		SURVIVOR SERIES Series 175/175R, 275/275R, 475/475R • 2-3/4" Backset		
75 Series Leverset Shown Below					Standard Features		
					<ul style="list-style-type: none"> • Backset: 2-3/4" • Latch #1134, Front: 1-1/8" x 2-1/4"; Throw: 1/2"; Stainless steel nose • Levers: Solid cast Zamac; w/ 1/2" return (except 475) • Roses: Thru-bolted, 3-1/4" dia., spring loaded 2-#10 thru-bolts • Strike: #1145, ASA strike • Door thickness: 1-5/8" to 1-7/8"; <i>For 1-3/8" door use K1904 spacer</i> • Cylinder: MARKS "C" keyway, 6 pin w/ 2 keys 		
MARKS #		FUNCTION	ANSI #	175	275, 475	175, 275, 475	
COMM. CYL.	IC CORE CYL.*			26D	26D	3, 4, 10, 10B, 26	
N	—	PASSAGE	F75	194	211	231	
L	—	PRIVACY	F76	234	251	271	
P	—	PATIO	F77	209	226	246	
DC	RDC	COMMUNICATING	F80	277	294	314	
A	RA	ENTRY	F81	234	251	271	
B	RB	ENTRY	F82A	234	251	271	
AB	RAB	ENTRY	F109	234	251	271	
AQ	—	EXIT	F83	224	241	271	
S	RS	CLASSROOM	F84	234	251	271	
F	RF	STOREROOM	F86	234	251	271	
DW	RDW	INSTITUTION	F87	281	300	320	
DA	RDA	VESTIBULE	F88	283	300	320	
FQ	—	EXIT	F89	224	241	271	
T	RT	CORRIDOR	F90	245	262	282	
BS	RBS	SERVICE STATION LOCK	F92	245	262	282	
H	—	HOTEL	F93	296	313	333	
DO	—	DUMMY TRIM OUTSIDE	—	80	96	117	
DT	—	FULL DUMMY TRIM	—	162	179	199	
NB	—	COMMUNICATING PASSAGE	F111	170	184	195	
FB	RFB	COMMUNICATING STOREROOM	F112	246	254	265	
SB	RSB	COMMUNICATING CLASSROOM	F113	246	254	265	

OPTIONS	CODE	PRICE - 175	275	475
2-3/8" backset, 1" x 2-1/4" face	E6	NC	NC	NC
2-3/4" backset, 9/16" throw, Gr. 1, UL Listed	E7	47	47	47
5" backset, 9/16" throw, Gr. 1	E9	47	47	47
3-3/4" backset, 9/16" throw, Gr. 1	E10	47	47	47
Less cylinder	G3	Deduct 15	-15	-15
2-3/4" T strike	S3	NC	NC	NC
AMERICAN LEVER ONLY Accepts:				
Yale conventional cylinde	F7	23	23	—
Sargent conventional cylinder	F8	23	23	—
Corbin conventional cylinder	F9	23	23	—
Corbin 6 pin IC core	F12	34	34	—
Corbin 7 pin IC core	F13	34	—	—
Yale 6 pin IC core	F14	23	23	—
Yale 7 pin IC core	F15	23	23	—
Schlage 6 pin IC core	F19	23	23	—
Sargent IC core	F20	23	23	—
AMERICAN & CRESCENT LEVER ONLY Accepts:				
Medeco IC core large format	F21	23	23	—

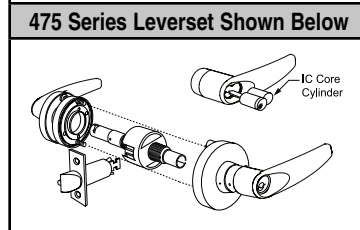
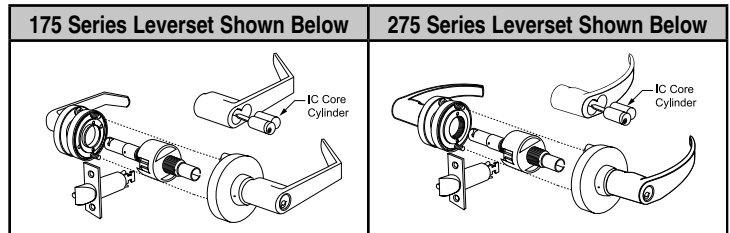

★ **Standard & HI-SECURITY™ IC Core Models:** Interchangeable Core models for 6 or 7 pin cores (not included). **Accepts:** Marks, Marks HI-SECURITY™, Medeco®, KeyMark™, Falcon, Schlage® small format & Best®. **IC Core Tailpieces ARE Included.**

CYLINDRICAL LOCK ACCESSORIES

Latches, Strikes, Etc.

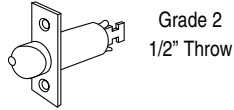

LATCH	THROW	Backset: 2-3/8" Front: 1" x 2-1/4"	Backset: 2-3/4" Front: 1-1/8" x 2-1/4"	FUNCTION	FINISH GROUPS		
					26D	3, 32D	10, 10B
GRADE 2	1/2"	1138A	1134A	ENTRANCE	—	44	53
		1138L	1134L	PRIVACY	—	32	44
		1138N	1134N	PASSAGE	—	32	44
		1138P	1134P	PATIO	—	44	53
GRADE 1	9/16"	—	1834A	ENTRANCE	—	89	97
		—	1834L	PRIVACY	—	75	89
		—	1834N	PASSAGE	—	75	89
		—	1834P	PATIO	—	75	89

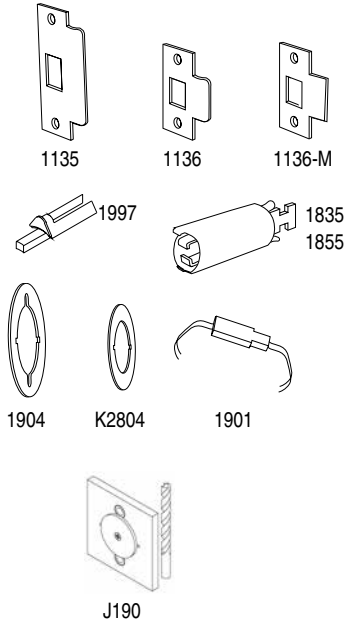

PART	#	DESCRIPTION	FINISH GROUPS	
			3, 32D	10, 10B
STRIKES	1135	4-7/8" ASA strike, curved lip	22	22
	P1136	2-3/4" "T" strike w/dust box, curved lip	13	21
	1136-M	2-3/4" "T" strike w/dust box, straight lip	14	22
SURVIVOR SERIES ALUMINUM SPACER RINGS	K1904	For 1-3/8" door (2 per set), 3-7/16" dia.	39	49
KNOB SPACER RINGS	K2804	For 1-3/8" door (2 per set), 2-3/4" dia.	39	50
PART	#	DESCRIPTION	NO FINISH	
EXTENSION LINK <i>For use with 2-3/4" Grade 1 backset latch</i>	1835	3-3/4"	32	
	1855	5"		
	1855-P	5" (Grade 1; L, P functions only)		
BRIDGE RECTIFIER	1901	Bridge rectifier 24 V AC/DC (no finish)	49	
CYLINDER RETAINER	1997	Lever handle cylinder retainer	5	
INSTALLATION TOOL	J295	175/195 installation drill jig	186	

CYLINDRICAL LOCK ACCESSORIES

Cylinders

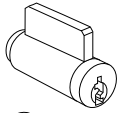

Conventional Cylinder

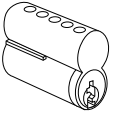

IC Core Cylinder
(Will Fit Best® Housings)

FOR KEYS & KEYING, SEE PAGE 76

PART #	DESCRIPTION	PRICE
1982	6 Pin, w/2 nickel-silver keys	34
R1182	6 Pin core, uncombined	43
* R1183	7 Pin core, uncombined	43
* RA1182	6 Pin core, combined	63
* RA1183	7 Pin core, combined	63
* RC1182	6 Pin core, construction core	45
* RC1187	Plastic core turnknob	7

Specify Tailpiece; *Tailpiece Not Included.*

IC core pricing includes KA, KD or MK Keying.

* Consult Factory on pricing of IC Cores when ordered with Locksets.

Cylindrical Lock Tailpieces

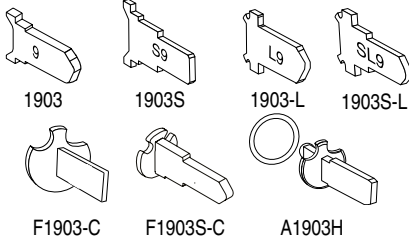

PART #	CODE	FUNCTION	CYLINDER	PRICE
1903	9	AB, B, DA (ext.), DW, F, FEL, FEU	MARKS 1982	6
1903S	S9	S, DA (int.), DB, DC, SB, T		
1903-L	L9	AB, B, DA (ext.), DW, F, FEL, FEU	Arrow PK 100C, Ilco 705, Lori 1539, Sargent 13-3266, Abloy, ASSA 65673, 65691	6
1903S-L	SL9	S, DA (int.), DB, DC, SB, T		
F1903-C	—	AB, B, DA (ext.), DW, F, FEL, FEU	Schlage 23-001, Primus, Corbin-Russwin 2000-034	8
F1903S-C	—	S, DA (int.), DB, DC, SB, T		

Cylindrical IC Core Tailpieces

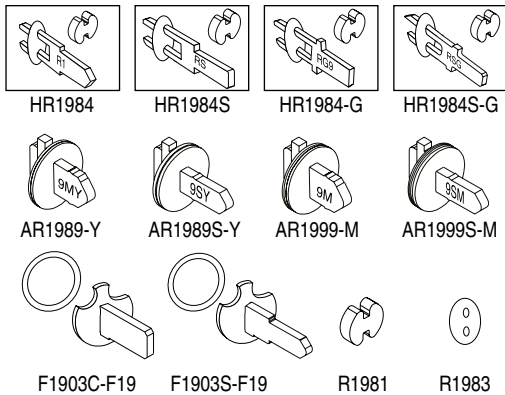

PART #	CODE	FUNCTION	CORE	PRICE
HR1984	R1	AB, B, DA (ext.), DW, F, FEU, FEL	6 or 7 pin Marks, KSP, Best®, Falcon, Medeco®, Keymark®, Sargent®, Schlage® Small Format	6
HR1984S	RS	S, DA (int.), DB, DC, SB, T		
HR1984-G	RG9	AB, B, DA (ext.), DW, F, FEU, FEL	6 or 7 pin Corbin	6
HR1984S-G	RSG	S, DA (int.), DB, DC, SB, T		
AR1989-Y	9MY	AB, B, DA (ext.), DW, F, FEU, FEL	6 or 7 pin Yale	8
AR1989S-Y	9SY	S, DA (int.), DB, DC, SB, T		
AR1999-M	9M	AB, B, DA (ext.), DW, F, FEU, FEL	Medeco®	8
AR1999S-M	9SM	S, DA (int.), DB, DC, SB, T	Medeco®	8
F1903C-F19	—	AB, DW, F	6 pin Schlage® Large Format	8
F1903S-F19	—	S, DA, DB, DC, SB, T		
R1981		Spacer		6
R1983		Security Disc		6

For Keying information see Pages 76-77

How To Order Example for Cylindrical Lock Cylinders & Tailpieces

1982	/	26D	—	9
1. Cylinder	Slash	2. Finish	Dash	3. Options

See list of cylinders available.

- | | | |
|------------------------------|------------------------------|----------------------------------|
| <input type="checkbox"/> 3 | <input type="checkbox"/> 26 | <input type="checkbox"/> Special |
| <input type="checkbox"/> 4 | <input type="checkbox"/> 26D | |
| <input type="checkbox"/> 10 | <input type="checkbox"/> 32 | |
| <input type="checkbox"/> 10B | <input type="checkbox"/> 32D | |

Tailpiece & keying information must be included in the option section.









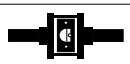

CYLINDRICAL KNOB/LEVER FUNCTIONS

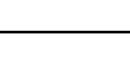







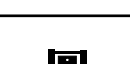
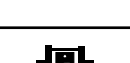

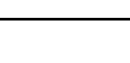

ANSI# CODE	MARKS FUNCTION
F75	.N
F76	.L
F76 (MOD.)	.LK
F77	.P
F80	.DC
F81	.A

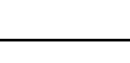
ANSI# CODE	MARKS FUNCTION
F82A	.B
F83	.AQ
F84	.S
F86	.F
F87	.DW
F88	.DA

ANSI# CODE	MARKS FUNCTION
F89	.FQ
F90	.T
F90 (MOD.)	.TK
F91 (95 Series Leverset ONLY)	.GB
F92	.BS
F93	.H

ANSI# CODE	MARKS FUNCTION
F109	.AB
F110	.DB
F111	.NB
F112	.FB
F113	.SB

ANSI # CODE	Marks Function	
	I/S	O/S
F75 PASSAGE: Latch by knob/lever either side.		N
F76 PRIVACY: Latch by knob/lever either side unless outside knob/lever locked by push-button from inside. Outside unlocks by turning inside knob/lever, outside emergency turn or closing door.		L
F76 (MOD.) HOSPITAL/PRIVACY: Latch by knob/lever either side unless outside knob/lever locked by push-button from inside. Outside unlocks by turning inside knob/lever, outside turn or closing door. Emergency turn-knob A5 option.		LK
F77 PATIO: Deadlocking latch by knob/lever either side unless outside knob/lever locked by push-button inside. Unlocks by turning inside knob/lever or closing door.		P
F80 COMMUNICATING: Key both sides. Locks or unlocks either knob/lever independent of the other. Deadlocking latch.		DC
F81 ENTRY: Deadlocking latch bolt by knob/lever either side except when outside locked by turn-button inside. When outside locked, key outside or knob/lever inside opens lock. Turn-button operated manually.		A
F82A ENTRY: Deadlocking latch by knob/lever either side. Outside locked by push-button inside. When outside locked by push-button inside, key opens lock, unlocks push-button. Inside knob/lever always opens latch. Closing door does not release push-button.		B
F83 EXIT: Deadlocking latch by knob/lever either side except when outside locked by turn-button inside. Inside knob/lever always opens latch. Turn-button operated manually.		AQ
F84 CLASSROOM: Deadlocking latch by knob/lever inside. Outside knob/lever locked or unlocked by key.		S
F86 STOREROOM: Deadlocking latch by knob/lever inside, key outside. Outside knob/lever always locked.		F
F87 INSTITUTION: Both knob/levers always locked. Deadlocking latch by key both sides.		DW
F88 VESTIBULE: Deadlocking latch by knob/lever either side, except when outside knob/lever locked by key inside. Key outside retracts deadlocking latch. Inside always open.		DA
F89 EXIT: Deadlocking latch by knob/lever inside. Outside always locked.		FQ
F90 CORRIDOR: Deadlocking latch by knob/lever either side unless outside locked by key or inside push-button. Unlock by key, turning inside knob/lever or closing door.		T

ANSI # CODE	Marks Function	
	I/S	O/S
F90 (MOD.) HOSPITAL/PRIVACY: Deadlocking latch by knob/lever either side unless outside locked by knob/lever or inside push-button. Unlock by turn-knob, turning inside knob/lever or closing door. Emergency turn-knob A5 option.		TK
F91 STORE DOOR (95 Series Leverset ONLY): Deadlocking latch by knob/lever either side except when both knob/levers are locked by key from either side.		GB
F92 SERVICE STATION LOCK: Deadlocking latch by knob/lever either side unless outside locked by key or inside push-button. Unlock by key, turning inside knob/lever or closing door, except when slotted push-button is turned in locked position. Inside knob/lever always opens latch.		BS
F93 HOTEL: Deadlocking latch by knob/lever inside. Outside knob/lever always locked. Inside push-button projects indicator on cylinder face shutting out all keys except emergency key. Turning inside knob/lever or closing door releases push-button.		H
F109 ENTRY: Outside locked by pushing turn-button inside. Key outside opens lock. Rotating inside knob/lever releases button and outside knob/lever. By pushing and turning inside button, outside knob/lever remains locked. Deadlocking latch.		AB
F110 CLASSROOM INTRUDER: Deadlocking latch by knob/lever either side, except when outside locked by key inside. Key outside locks or unlocks outside. Inside always open		DB
DUMMY TRIM: Outside only, rigid.		DO
DUMMY TRIM: Both sides, rigid.		DT
F111 COMMUNICATING PASSAGE: Blank outside. Deadlocking latch by knob/lever inside.		NB
F112 COMMUNICATING STOREROOM: Blank outside. Deadlocking latch by key only. Knob/lever always locked.		FB
F113 COMMUNICATING CLASSROOM: Blank outside. Inside knob/lever locked or unlocked by key. Deadlocking latch.		SB
ELECTRICALLY LOCKED - FEL (Fail Safe): Outside always locked electrically. Open by key outside, switch or loss of power. Deadlocking latch by lever inside. Lever only.		FEL
ELECTRICALLY UNLOCKED - FEU (Fail Secure): Outside always locked until unlocked by key or electrically energized. Deadlocking latch by lever inside. Lever only.		FEU

Cylindrical Locksets

How To ORDER TUBULAR LOCKSETS

How To Order Example for Tubular Locksets

1	RW	92	N	/	32D	—	S3
<i>1. Lockset Series</i>	<i>2. Rose Design</i>	<i>3. Knob/Lever</i>	<i>4. Marks Function</i>	<i>Slash</i>	<i>5. Finish</i>	<i>Dash</i>	<i>6. Options</i>

1 SERIES	
Tubular Locksets	1
Cylindrical Cartridge	1

2 ROSES		
ROSES		DESIGN
9602-R	Rose with ring 2-9/16" dia.	RR
9602	Plain rose 2-9/16" dia.	RW
5602-R	Small rose with ring 2-1/4" dia.	RQ
5602	Small rose 2-1/4" dia.	RS
7602	Square rose 2-9/16" square	RX
7607	Square forged rose 2-9/16" square	RK

3 KNOB/LEVER		
KNOBS		DESIGN
1153	Round, wrought	10
1253	Ball, wrought	20
9631	Ball, forged	30
9609	Eclipse, forged	60
LEVERS		DESIGN
SF031	Copa	031
5642	Palace	42
5657	Monaco	57
5662	Royale	62
5672	Towne	72
5677	Maxwell	77
5678	Omni	78
5682	Plaza	82
5683	Dayton	83
5686	Crescent	86
5692	American	92
5696	Titan	96

4 TUBULAR FUNCTIONS		
MARKS #		ANSI #
TUBULAR LOCKSETS		
N	PASSAGE	F75
L	PRIVACY	F76
NB	COMMUNICATING	F111
DI	DUMMY TRIM INSIDE	
DO	DUMMY TRIM OUTSIDE	
DT	FULL DUMMY	

5 FINISH		
MARKS		ANSI #
US 3	Polished Brass, Clear Coated	605
US 3E	Polished Brass "PVD"	605E
US 4	Satin Brass, Clear Coated	606, 606E
US10	Satin Bronze, Clear Coated	612E
US 10B	Dark Bronze, Clear Coated	613E
US15	Satin Nickel	619, 619E
US 26	Polished Chrome, Plated	625
US 26D	Satin Chrome, Plated	626
US 32	Polished Stainless Steel	629
US 32D	Satin Stainless Steel	630

6 OPTIONS		
TRIM MODIFICATIONS	CODE	PRICE
Tactile knob/lever, coated ext. only	A1	60
Tactile knob/lever, knurled	A4	60
Tactile knob/lever, coated int. & ext.	A18	122
DOOR THICKNESS	CODE	PRICE
1-3/4"	D4	NC
1-3/8"	D5	NC
LATCH	CODE	PRICE
2-3/4" backset, 1-1/8" x 2-1/4" face	E4	10
2-3/4" backset, 9/16" throw, Gr. 1, UL Listed With Cylindrical Cartridge*		
2-3/8" backset, 1-1/8" x 2-1/4" face	E7	107
2-3/4" backset, 1-1/8" x 2-1/4" face	E11	13
2-3/4" backset, 1 x 2-1/4" face	E12	13
Adjustable latch 1-1/8" x 2-1/4" face	E13	10
TRIM CHANGES	CODE	PRICE
For 1-1/2" bore	F6	17
STRIKE	CODE	PRICE
4-7/8" ASA strike	S1	13
2-3/4" "T" strike	S3	NC
3-5/8" Security strike	S4	11
2-1/4" Curved lip strike	S5	NC

* E7 Option Available: 2-3/8", 2-3/4", 3-3/4" & 5" Backset, for N Function ONLY.

TUBULAR KNOB/LEVER FUNCTIONS









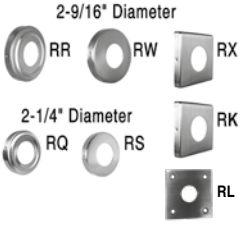

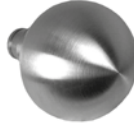



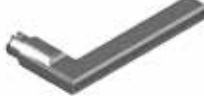





ANSI # CODE	MARKS FUNCTION						
F75 PASSAGE: Latch by knob/lever either side.	<table border="1"> <tr> <td>I/S</td> <td>O/S</td> <td></td> </tr> <tr> <td></td> <td></td> <td>N</td> </tr> </table>	I/S	O/S				N
I/S	O/S						
		N					
F76 PRIVACY: Latch by knob/lever either side unless outside knob/lever locked by push-button from inside. Outside unlocks by turning inside knob/lever, outside emergency turn or closing door.	<table border="1"> <tr> <td>I/S</td> <td>O/S</td> <td></td> </tr> <tr> <td></td> <td></td> <td>L</td> </tr> </table>	I/S	O/S				L
I/S	O/S						
		L					
F111 COMMUNICATING: Blank outside. Deadlocking latch by knob/lever inside.	<table border="1"> <tr> <td>I/S</td> <td>O/S</td> <td></td> </tr> <tr> <td></td> <td></td> <td>NB</td> </tr> </table>	I/S	O/S				NB
I/S	O/S						
		NB					

ANSI # CODE	MARKS FUNCTION						
DUMMY TRIM INSIDE: Dummy trim inside ONLY.	<table border="1"> <tr> <td>I/S</td> <td>O/S</td> <td></td> </tr> <tr> <td></td> <td></td> <td>DI</td> </tr> </table>	I/S	O/S				DI
I/S	O/S						
		DI					
DUMMY TRIM OUTSIDE: Dummy trim outside ONLY.	<table border="1"> <tr> <td>I/S</td> <td>O/S</td> <td></td> </tr> <tr> <td></td> <td></td> <td>DO</td> </tr> </table>	I/S	O/S				DO
I/S	O/S						
		DO					
FULL DUMMY TRIM: Dummy trim both sides.	<table border="1"> <tr> <td>I/S</td> <td>O/S</td> <td></td> </tr> <tr> <td></td> <td></td> <td>DT</td> </tr> </table>	I/S	O/S				DT
I/S	O/S						
		DT					

ROSE DESIGN RR, RW, RQ, RS, RX*, RK*, RL*

Tubular Locksets

ANSI-A156 • Grade 2			Series 1 • 2-3/8" Backset					
Standard Features			KNOBS			LEVERS		
 <p>2-9/16" Diameter RR RW RK 2-1/4" Diameter RQ RS RK RL</p>	<ul style="list-style-type: none"> • Backset: 2-3/8", 2-3/4" optional • Front: 1" x 2-1/4" • Thru-bolted screwless knob/lever rose • Concealed mounting screws • Lever support springs • Independent spring loaded captivated spindles • Strike: 2-1/4" full curved lip • Latch support housing • Door thickness: 1-3/8" to 1-3/4" • Privacy function - interior with automatic release 		10, 20	30, 60		031, 44, 55, 57, 72, 77, 78, 82, 83, 86, 92, 96		82, 83, 86, 92, 96
	FINISH GROUPS							
MARKS #	FUNCTION	ANSI #	3, 32D	3E, 15	10B, 26	3E, 4, 15, 26D	10E, 10B, 19E 14, 26	32, 32D
KEYLESS								
N	PASSAGE	F75	235	300	337	316	353	304
L	PRIVACY	F76	246	311	348	326	364	315
NB	COMMUNICATING	F111	288	288	326	305	342	294
DUMMY TRIM								
DI	DUMMY TRIM INSIDE		110	142	212	151	169	144
DO	DUMMY TRIM OUTSIDE							
DT	FULLY DUMMY		219	284	321	300	337	288
NOTE: Split designs and/or finishes are priced at the highest design and/or finish • Special finishes, consult factory								
*Square Rose RX: Add \$30 / *Square Rose RZ: Add \$70 / *Square Rose RK: Add \$100								

KNOBS	Round Knob 10	Ball Knob 20	Ball Knob 30	Eclipse Knob 60	ROSES	RR: 2-9/16" dia.	
							
LEVERS	Stanhope Lever 44	Copa Lever 031	Brompton Lever 55	Monaco Lever 57 Specify handing	RW: 2-9/16" dia.		
							
	Towne Lever 72	Maxwell Lever 77	Omni Lever 78	Plaza Lever 82 Specify handing	RQ: 2-1/4" dia.		
							
	Dayton Lever 83 Specify handing	Crescent Lever 86	American Lever 92	Titan Lever 96	RS: 2-1/4" dia.		
							
					RX: 2-1/2" sq.	RK: 2-1/2" sq.	RL: 1-1/2" sq.
							

OPTIONS	CODE	PRICE	NOTE
1-3/8" door thickness	D5	NC	
2-3/4" backset, 1-1/8" x 2-1/4" face	E4	10	
2-3/4" backset, 9/16" throw, Gr. 1, UL Listed WITH CYLINDRICAL CARTRIDGE *	E7	107	N Function Only
2-3/8" backset, 1-1/8" x 2-1/4" face	E11	13	
2-3/4" backset, 1" x 2-1/4" face	E12	13	
4-7/8" ASA strike	S1	13	
2-3/4" "T" strike	S3	NC	
US 26 Interior	x26	24	83, 92, 96 Only

* E7 Option Available: 2-3/8", 2-3/4", 3-3/4" & 5" Backset, for N Function ONLY.

INTERIOR TUBULAR LOCKSETS





NEW! 60 Series, Stainless Steel, Commercial Locksets

Standard Features

- Latch Face: 1" x 2-1/4" standard
- Backset: 2-3/4" with 2-3/4" T-strike with square corners
- Door thickness: 1-3/8" to 1-3/4"
- Roses: 2-9/16" diameter
- Backset: 2-3/8" with 2-1/4", radius corner full lip strike, option E6, N/C
- Privacy Function with kick-off latch

MARKS #	FUNCTION	ANSI #	FINISH GROUPS (160, 260 & 360)	
				32D
N	PASSAGE	F75		140
L	PRIVACY	F76		150
DO	DUMMY TRIM OUTSIDE	—		70

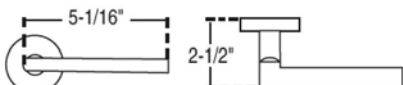
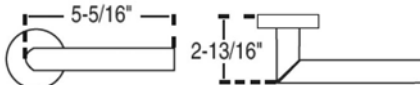
LEVERS ARE PACKED 9 PER CASE Additional finishes, consult factory

160 Series Finishes: 32D	260 Series Finishes: 32D	360 Series Finishes: 32D
		
		

50 Series, Residential Leversets

Standard Features

- Pressure cast Levers
- Roses: 2-15/16" diameter
- Adjustable Backset: 2-3/8" - 2-3/4"
- Latch: 1" x 2-1/4" front, 1/2" throw
- Door thickness: 1-3/8" to 1-3/4"
- Privacy Function with kick-off latch
- Strike: 2-1/4" full lip strike
- NOTE: Latches & strikes have radius corners**

MARKS #	FUNCTION	ANSI #	FINISH GROUPS (150, 250 & 450)	
				26D
N	PASSAGE	F75		66
L	PRIVACY	F76		78
DO	DUMMY TRIM OUTSIDE	—		34

LEVERS ARE PACKED 24 PER CASE Additional finishes, consult factory

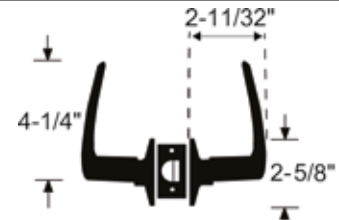
150 Series American Lever Finishes: 26D	250 Series Crescent Lever Finishes: 26D	450 Series Titan Lever Finishes: 26D
		
		

TUBULAR LOCKSET ACCESSORIES

Strikes, Latches, Support Housing

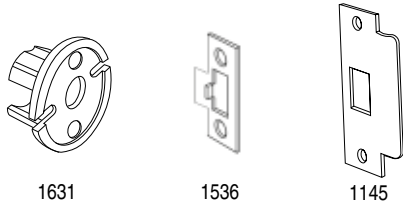

1631

1536

1145

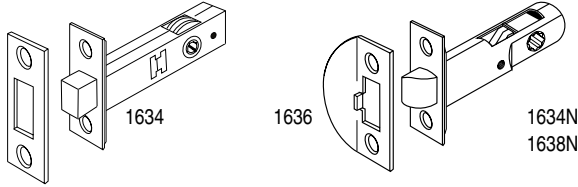

1634

1636

1634N

1638N

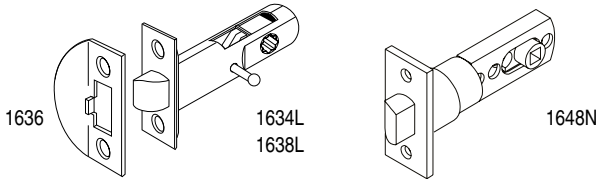

1636

1634L

1638L

1648N

PART #	DESCRIPTION	BACKSET FRONT	FINISH GROUPS		
			NO FINISH	3, 26	10, 10B, 32
1631	Support housing	—	9	—	—
1536	"T" Strike, 2-3/4" curved lip	—	—	9	15
1145	4-7/8" ASA strike	—	—	11	21
1634	Tubular deadbolt	2-3/4"	—	104	111
1636	Strike, 2-1/4" full curved lip	—	—	9	15
1634N	Passage latch w/ strike	2-3/4"	—	74	88
1634L	Privacy latch w/ strike	1" x 2-1/4"	—	88	98
1638N	Passage latch w/ strike	2-3/8"	—	48	60
1638L	Privacy latch w/ strike	1" x 2-1/4"	—	60	72
1648N	UL Listed Adjustable Backset Latch RESIDENTIAL INTERIOR LOCKSETS ONLY	2-3/8" - 2-3/4"	—	—	95

Turnpieces



SKA03

SKA015

1351

8101P

5108

A7616

PART #	DESCRIPTION	FINISH GROUPS					
		3E	3	26D	4	10, 10B, 26	32D
SKA03	Turnpiece	—	—	—	—	—	83
SKA015	Turnpiece	71	54	54	71	63	—
1351	Turnpiece	—	—	73	—	—	—
8101P	Turnpiece	60	43	43	60	51	51
5108	Turnpiece	—	—	73	—	—	—
A7616	Turnpiece	71	54	54	71	63	63

Latches & Cylindrical Cartridge

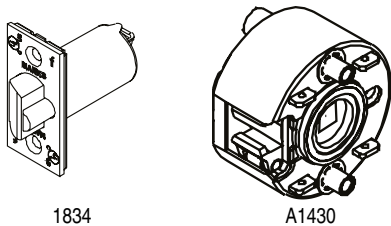

1834

A1430

Cylindrical Cartridge

NOTE: Cylindrical Cartridge is for use with E7* Option ONLY.

LATCH	THROW	Backset 2-3/8"; Front 1" x 2-1/4"	Backset 2-3/4"; Front 1-1/8" x 2-1/4"	FUNCTION	FINISH GROUPS	
					3, 32D	10, 10B
GRADE 2	1/2"	1138A	1134A	ENTRANCE	43	53
GRADE 1	9/16"	—	1834A	ENTRANCE	89	96

PART #	DESCRIPTION	NO FINISH
A1430	Cylindrical Cartridge	107

How To Order DEFENDER LOCKSETS

How To Order Example for Defender Locksets					
145	K	/	32D	—	D1
<small>1. Lockset Series</small>	<small>2. Marks Function</small>	<small>Slash</small>	<small>3. Finish</small>	<small>Dash</small>	<small>4. Options Specify: Keying, Handing & Door Thickness</small>

1 SERIES	
Defender Tubular Deadbolt Locksets	130, 130R
Defender Cylindrical Cartridge Deadlatch Locksets	145, 145R

2 TUBULAR FUNCTIONS			
DEADBOLT/DEADLATCHES (* indicates IC Core)			
		130 Series	145 Series
K	RK*	CYLINDER x TURNPIECE	E0151 E01101
KK	RKK*	CYLINDER x KNOB	
L	RL*	COMM. SINGLE CYLINDER	E0161 E0131
KL	RKL*	CYLINDER x LEVER	E01101
M	RM*	DOUBLE CYLINDER	E0141 E01111
S	RS*	CLASSROOM	E0171
X		TURNPIECE	E0191 E01121

3 FINISH		
MARKS		ANSI #
US 3	Polished Brass, Clear Coated	605
US10	Satin Bronze, Clear Coated	612E
US 10B	Dark Bronze, Clear Coated	613E
US 26D	Satin Chrome, Plated	626
US 32	Polished Stainless Steel	629
US 32D	Satin Stainless Steel	630



4 OPTIONS		
TRIM MODIFICATIONS	CODE	PRICE
Tactile knob/lever, coated ext. only	A1	60
Tactile knob/lever, knurled	A4	60
Tactile knob/lever, coated int. & ext.	A18	122
DOOR THICKNESS	CODE	PRICE
50 mm (2")	D1	NC
57 mm (2-1/4")	D2	51
1-1/4" - 1-1/2"	D8	NC
LATCH	CODE	PRICE
2-3/4" backset, 1-1/8" x 2-1/4" face	E4	10
2-3/8" backset, 1-1/8" x 2-1/4" face	E11	12
TRIM CHANGES	CODE	PRICE
Sargent conventional cylinder	F8	22
CYLINDER	CODE	PRICE
Less cylinder	G3	Deduct 15
STRIKE	CODE	PRICE
4-7/8" ASA strike	S1	13
4-7/8" x 1-1/4" security strike	S4	11



Defender Series

DEADBOLT/DEADLATCH FUNCTIONS

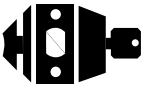
ANSI # CODE	MARKS # FUNCTION
130 SERIES:	
E0151	K
E0161	L
E0141	M
E0171	S
E0191	X

ANSI # CODE	MARKS # FUNCTION
145 SERIES:	
E01101	K
E0131	L
E01101	KL
E01111	M
E01121	X

ANSI # CODE	Marks Function	
	I/S	O/S
CYLINDER x TURNPIECE: Deadbolt/deadlatch by inside turnpiece or outside key.		K
COMMUNICATING SINGLE CYLINDER: Deadbolt/deadlatch by key from one side only.		L
CYLINDER x LEVER: Deadlatch by key outside. Inside lever always opens latch.		KL

ANSI # CODE	Marks Function	
	I/S	O/S
DOUBLE CYLINDER: Deadbolt/deadlatch by key either side.		M
CLASSROOM: Deadbolt by outside key. Turnpiece will retract but not project deadbolt.		S
TURNPIECE x BLANK PLATE: Deadbolt/deadlatch by inside turnpiece. Blank plate outside.		X

130 SERIES "DEFENDER" TUBULAR DEADBOLTS

ANSI 156.5				Standard Features	
 130K				<ul style="list-style-type: none"> Bolt: 1" throw Unitized assemblies for 2-1/8" bore Strike: #1335, 2-3/4" x 1-1/8" strike Door thickness: 1-3/8" to 1-7/8" Cylinder: MARKS "C" keyway, 6 pin w/ 2 keys 2-3/8" Backset Latch front: 1" x 2-1/4" 	
MARKS #		FUNCTION	ANSI #	FINISH GROUPS	
COMM. CYL.	IC CORE CYL.*			3, 10, 10B, 32, 32D	
K	RK	CYLINDER x TURNPIECE	E0151	204	
L	RL	COMMUNICATING SINGLE CYL	E0161	204	
M	RM	DOUBLE CYLINDER	E0141	197	
S	RS	CLASSROOM	E0171	178	
X	—	TURNPIECE x BLANK PLATE	E0191	143	

DEADBOLTS ARE PACKED 24 PER CASE

NOTE: Split designs and/or finishes are priced at the highest design and/or finish • Special finishes, consult factory
• IC Core Models: Core not included

OPTIONS	CODE	PRICE
For 2" door	D1	NC
For 2-1/4" door	D2	51
For 1-1/4" - 1-1/2" door	D8	NC
2-3/4" backset, 1-1/8" x 2-1/4" face	E4	11
For 1-1/2" bore	F6	20
Sargent original cylinder or core	F8	22
Less cylinder	G3	Deduct 15
3-5/8" x 1-1/4" Security strike	S4	13

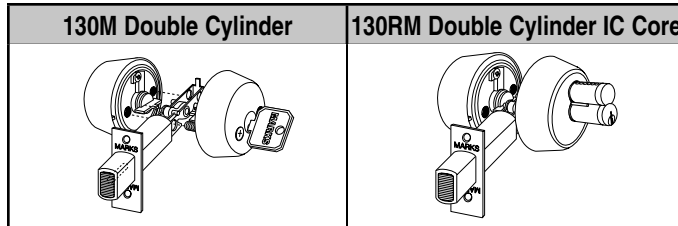

*** Standard IC Core Models:** 

Interchangeable Core models for 6 or 7 pin cores (not included).
Accepts: Marks, Medeco KeyMark™, Falcon & Best®. IC Core Tailpieces ARE Included.

145 SERIES "DEFENDER" CYLINDRICAL CARTRIDGE DEADLATCHES

BHMA CERTIFIED		ANSI 156.5 • 3 Hour Fire Rating	UL LISTED	Standard Features	
 145M				<ul style="list-style-type: none"> Series 1 Cylindrical Cartridge Latch: Grade 1, 9/16" throw, 2-3/4" backset Unitized assemblies for 2-1/8" bore Strike: #1136, 2-3/4" strike Door thickness: 1-3/4"; For 1-3/8" doors use spacer rings K1442/32D Cylinder: MARKS "C" keyway, 6 pin w/ 2 keys Latch front: 1-1/8" x 2-1/4" 	
MARKS #		FUNCTION	ANSI #	FINISH GROUPS	
COMM. CYL.	IC CORE CYL.*			3, 10, 10B, 32, 32D	
K	RK	CYLINDER x TURNPIECE	E01101	220	
L	RL	COMMUNICATING SINGLE CYL	E0131	220	
M	RM	DOUBLE CYLINDER	E01111	239	
X	—	TURNPIECE x BLANK PLATE	E01121	187	
KL	RKL	CYLINDER x LEVER	E01101	373	
KK	RKK	CYLINDER x KNOB		387	

DEADLATCHES ARE PACKED 24 PER CASE

NOTE: Split designs and/or finishes are priced at the highest design and/or finish • Special finishes, consult factory
• IC Core Models: Core not included

OPTIONS	CODE	PRICE
For 2" door	D1	NC
For 2-1/4" door	D2	53
2-3/8" backset, 1-1/8" x 2-1/4" face	E11	13
Sargent original cylinder or core	F8	22
Less cylinder	G3	Deduct 15
4-7/8" ASA strike	S1	13

*** Standard IC Core Models:** 

Interchangeable Core models for 6 or 7 pin cores (not included).
Accepts: Marks, Medeco KeyMark™, Falcon & Best®. IC Core Tailpieces ARE Included.

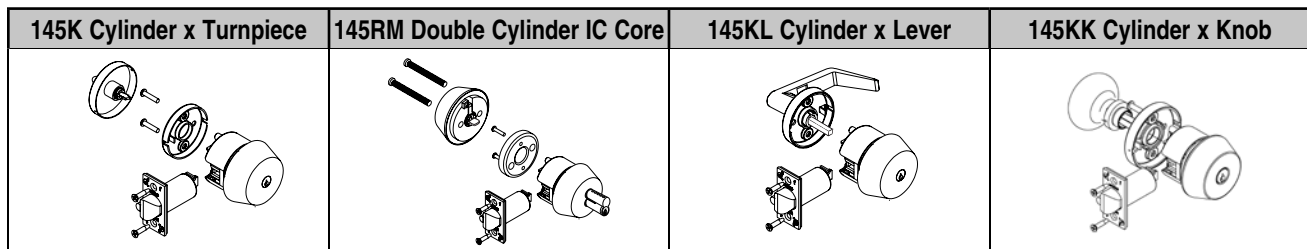

DEFENDER SERIES ACCESSORIES

Strikes, Latches & Spacers

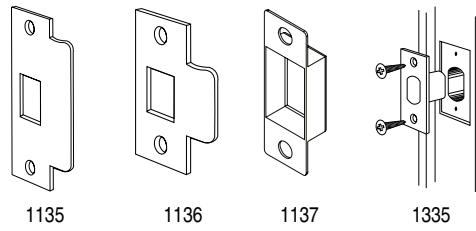

1135

1136

1137

1335

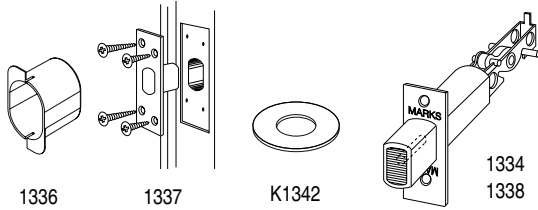

1336

1337

K1342

1334

1338

PART #	DESCRIPTION	FINISH GROUPS		
		NO FINISH	3, 32D	10, 10B, 32
1135	4-7/8" ASA STRIKE	—	22	22
1136	2-3/4" "T" STRIKE W/DUST BOX	—	9	14
1137	DUST BOX, PLASTIC, LATCH	5	—	—
1335	2-3/4" x 1-1/8" STANDARD STRIKE	—	7	9
1336	DUST BOX, PLASTIC, DEADBOLT	5	—	—
1337	3-5/8" x 1-1/4" HIGH SECURITY STEEL STRIKE, PLATED FINISH	—	66	—
K1342	1-3/8" DOOR, ROSE EXTENDERS, 130 Series	—	52	65
DEADBOLTS				
1334	2-3/4" BACKSET FRONT 1-1/8" x 2-1/4"	—	34	43
1338	2-3/8" BACKSET FRONT 1-1/8" x 2-1/4"	—	34	43
K1442	1-3/8" DOOR, 145 SERIES	—	150	—

Latches & Cylindrical Cartridge

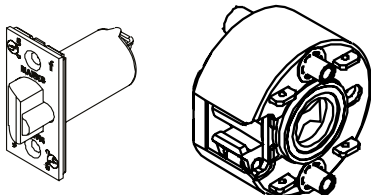

1834

A1420 Cylindrical Cartridge for use with 145 Series

NOTE: Cylindrical Cartridge is for use with E7* Option ONLY.

LATCH	THROW	Backset 2-3/8" Front 1" x 2-1/4"	Backset 2-3/4" Front 1-1/8" x 2-1/4"	FUNCTION	FINISH GROUPS	
					3, 32D	10, 10B
GRADE 2	1/2"	1138A	1134A	ENTRANCE	43	53
GRADE 1	9/16"	—	1834A	ENTRANCE	89	96

PART #	DESCRIPTION	NO FINISH
A1420	Cylindrical Cartridge for use with 145 Series	107

Tailpieces & Cylinders

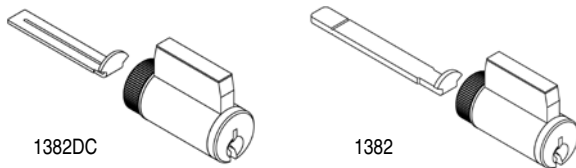

1382DC

1382

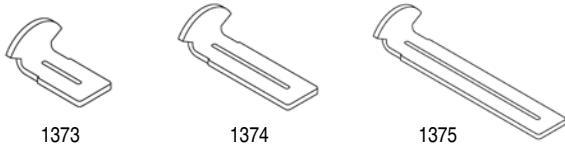

1373

1374

1375

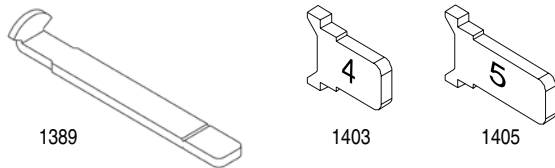

1389

1403

1405

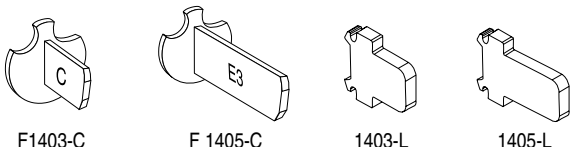

F1403-C

F1405-C

1403-L







1405-L

PART #	TAILPIECES FOR 130 DEADBOLTS	PRICE	
DOUBLE CYLINDER			
1373	1-5/16" to 1-3/8"	MARKS 1382DC	
1374	1-5/8" to 2"		5
1375	2-1/8" to 2-3/8"		5
SINGLE CYLINDER			
1389	1-3/4" to 2-1/4"	MARKS 1382	
TAILPIECES FOR 145 DEADLATCHES			
1403	1-5/8" to 1-7/8"	MARKS TAILPIECE	
1405	2" to 2-1/4"		5
F1403-C	1-5/8" to 1-7/8"	SCHLAGE® TAILPIECE	
F1405-C	2" to 2-1/4"		6
1403-L	1-5/8" to 1-7/8"	LORI / ILCO TAILPIECES	
1405-L	2" to 2-1/4"		6

I-QWIK LITE² SERIES



NO-NONSENSE ACCESS CONTROL RIGHT OUT OF THE BOX

MARKS #		LOCKSET TYPE - PACKED PER CASE	# OF USERS	FINISH GROUPS	
IQ1LITE	IQ1L/26D			19 Black Powder Coat; with 26D American Levers	26D Satin Chrome
		IQ1: Cylindrical Lockset - <i>PACKED 4 PER CASE</i>	160	551	635
		IQ2: Mortise Lockset - <i>PACKED 4 PER CASE</i>	160	890	974
		IQ7: Rim Exit Device Interface - <i>PACKED 6 PER CASE</i> <i>Adapter plates operate most manufacturers Rim Exit Devices.</i> <i>Adapter plates for Mounting Exit Devices are sold separately, see page 70.</i>	160	774	858

Access Control

Standard Features

- **CableGuard™** protects wires for easy installation
- Standard ANSI door prep with one additional hole
- Pre-programmed code
- Keypad programmable
- 160 User codes
- Temporary user codes
- Passage mode
- Pin only mode
- Double code entry for maximum security
- Two wire remote release
- 16 Digit tactile metal keypad
- Weatherproof standard
- Audible & visible entry indicator
- Audible low battery alert
- 4 "AA" batteries, 95,000 operations
- Easy installation
- Lifetime Mechanical Warranty; 2 Year Electronic Warranty

IQ1 LITE Cylindrical Lockset Specifications

Door Thickness: 1-3/4" standard;
For thicker doors, Consult factory

Handing: Non-handed

Key Override: Marks "C" keyway, 6 pin w/2 keys, IC Core optional

Lock Body: Cylindrical "Survivor" featuring the "Clutch" for trouble free service

Latch: Grade 2, 2-3/4" backset, 1/2" throw, 3 Hour UL fire rating

Strike Plate: 4-7/8" ASA strike

IQ2 LITE Mortise Lockset Specifications

Door Thickness: 1-3/4" standard;
For thicker doors, Consult factory

Handing: Field reversible

Key Override: 1-1/8" Mortise cylinder, 6 pin w/2 keys

Lock Body: Grade 1, Series 5, 2-3/4" backset, 3/4" anti-friction latch, 3 Hr UL fire rating

Auxiliary Latch: 1/2" throw

Clutch: The "Clutch" for trouble free service

Strike Plate: 4-7/8" ASA standard

IQ7 LITE Rim Exit Device Interface Specifications

Door Thickness: 1-3/4" standard;
For thicker doors, Consult factory

Handing: Non-handed

Key Override: 1-1/8" Mortise cylinder, 6 pin w/2 keys

Clutch: The "Clutch" for trouble free service

Adapter plates operate most manufacturers Rim Exit Devices. Adapter plates for Mounting Exit Devices are sold separately, see page 70.

How To Order Example for i-Qwik LITE Series Electronic Access Control Locksets

IQ	1LITE	
1. Lockset Series	2. Model Number	26D Finish

IQ

1LITE (Cylindrical)

1L/26D (Cylindrical)

2LITE (Mortise)

2L/26D (Mortise)

7LITE (Rim Exit Device Interface)

7L/26D (Rim Exit Device Interface)

I-QWIK/I-QUE SERIES

OPTIONS



I-QWIK / I-QUE OPTIONS			Cylindrical			Mortise			Rim Exit Device Interface		
DESCRIPTION	CODE	PRICE	IQLITE	IQDATA	IQPROX	IQLITE	IQDATA	IQPROX	IQLITE	IQDATA	IQPROX
Backset											
2-3/8" Backset	E6	NC	•	•	•						
5" Backset	E9	47	•	•	•						
3-3/4" Backset	E10	47	•	•	•						
Series 55 Mortise Lock Body (2-1/2" bkst)	W8	NC				•	•	•			
Levers											
Tactile Lever	A1	60	•	•	•	•	•	•	•	•	•
Lever to accept Sargent conventional cyl.	F8	23	•	•	•						
Lever to accept Corbin conventional cyl.	F9	23	•	•	•						
Lever to accept Corbin IC Core 6 pin	F12	34	•	•	•						
Lever to accept Corbin IC Core 7 pin	F13	34	•	•	•						
Lever to accept Yale IC Core 6 pin	F14	23	•	•	•						
Lever to accept Yale IC Core 7 pin	F15	23	•	•	•						
Lever to accept Schlage IC Core 6 pin	F19	23	•	•	•						
Lever to accept Sargent IC Core	F20	23	•	•	•						
Lever to accept Medeco IC Core lg. format	F21	23	•	•	•						
Monaco Lever	W3	20	•	•	•	•	•	•	•	•	•
Solid Exterior Handle (no cylinder)	W4	NC	•	•	•	Std	Std	Std	Std	Std	Std
Crescent Lever	W7	20	•			•	Std	Std	•	Std	Std
Titan Lever	W12	20	•	•	•	•	•	•	•	•	•
Cylinder											
IC Core Cylinder Housing	G1	NC	•	•	•	•	•	•	•	•	•
Less Cylinder	G3	Deduct 15	•	•	•	•	•	•	•	•	•
Strike											
4-7/8" ASA Strike	S1	13	•	Std	Std	Std	Std	Std			
2-3/4" "T" Strike	S3	NC	Std	•	•						
Miscellaneous											
Tamper-proof Screws	A3	14	•	•	•	•	•	•	•	•	•
Lead Lined IQ	F22	511	•	•	•	•	•	•	•	•	•

Access Control







I-QWIK/I-QUE SERIES



ACCESSORIES, TAILPIECES & CAMS

I-QWIK / I-QUE ACCESSORIES			Cylindrical			Mortise			Rim Exit Device Interface		
ACCESSORY	PART #	PRICE	QDLITE	QDATA	QPROX	QDLITE	QDATA	QPROX	QDLITE	QDATA	QPROX
Bridge rectifier (converts AC power to DC power)	1901	41	•	•	•	•	•	•	•	•	•
Gasket (interior inside housing for full weatherproofing)	E1108	7	•	•	•	•	•	•			
Battery Pack Holder	EA4011	20	•	•	•	•	•	•	•	•	•
Spacer Kit, 1-3/8" Door (Int. & Ext. Gaskets)	EK1038	60	•	•	•	•	•	•	•	•	•
Internal power connector for hardwiring i-Qwik/i-Que Locksets	E1133	29	•	•	•	•	•	•	•	•	•
Memory Reset Jumper	E1155	20	•	•	•	•	•	•	•	•	•
Spacer Ring for 1-1/4" mortise cylinder	E2006	20				•	•	•	•	•	•
Spacer Ring for 1-3/8" mortise cylinder	E2007	20				•	•	•	•	•	•
Von Duprin 99 Rim Adapter Plate / M9900 Marks Detex Advantex 10 Series Rim Adapter Plate	E7071	78							•	•	•
Precision 1100 Rim Adapter Plate	E7072	78							•	•	•
Yale 7100 Rim Adapter Plate/ Corbin ED5200 Rim Adapter Plate	E7073	78							•	•	•
Dorma 9300 Rim Adapter Plate	E7074	78							•	•	•
Sargent 8800 Rim Adapter Plate/ Arrow 3800 Rim Adapter Plate	E7075	78							•	•	•
Precision 21 Rim Adapter Plate/ Precision 2100 Rim Adapter Plate**	E7076	78							•	•	•
Von Duprin 88 - Special Order, Consult Factory	E7077	78							•	•	•
Monarch 18R Exit Device Adapter Plate	E7078	88							•	•	•

NOTE: Consult Factory for Additional Exit Devices; **Must use Precision #BP21 backplate.

TAILPIECES & CAMS

CYLINDRICAL TAILPIECES Cylindrical Conventional				
FOR USE WITH		LEVER	CODE	PRICE
	Marks 1982	E1903	E1	6
	Arrow PK 100C, ILCO 705, Sargent 13-3266, Lori 1539, ASSA 65673, 65691, Abloy	E1903-L	E2	6
	Schlage® 23-001, Primus Corbin-Russwin 2000-034	EF1903-C	E3	8
CYLINDRICAL IC CORES				
	Kit for 6 & 7 pin Marks, KSP, Best®, Falcon, Medeco® Keymark, Schlage® Small Format, 6 pin Sargent	HER1984	ER	6
	Kit for 6 & 7 pin Corbin	HER1984-G	ERG	6
	Kit for 6 & 7 pin Yale™ American Lever ONLY	EAR1989-Y	EMY	8
	6 pin Schlage® Large Format American Lever ONLY	EF1903-F19	CM	8

CAMS				
Straight cam for tubular, exit device, or mortise functions Z1 & Z4 only.				
	USE WITH MORTISE CYLINDER	PART #	CODE	PRICE
	MARKS	2101	1	6
	Arrow/Sargent	2101-A	A1	6
	Corbin Russwin	2101-C	C1	6
	Schlage®	2101-S	S1	6
CAMS				
Cloverleaf cam for mortise functions Z2, Z3, Z5, Z6 only.				
	USE WITH MORTISE CYLINDER	PART #	CODE	PRICE
	MARKS	2102	2	6
	Arrow/Sargent	2102-A	A2	6
	Corbin Russwin	2102-C	C2	6
	Schlage®	2102-S	S2	6

REQUEST To EXIT (REX)

CYLINDRICAL ELECTRIFIED LEVERSET

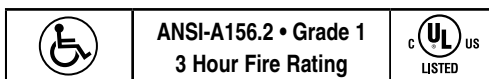

EA195 Series Leverset w/American Lever



Marks USA has developed the Grade 1 "Survivor" Series Cylindrical Lockset incorporating a Request to Exit (REX) switch in both Electrified and Storeroom functions. Activating the inside lever for egress initiates the built-in REX output, providing a momentary signal for the access control REX input, for alarm shunt during egress.

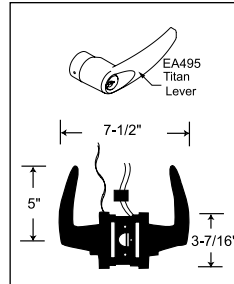
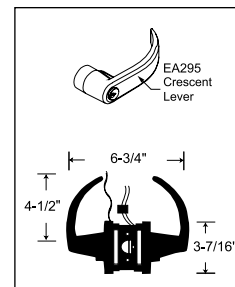
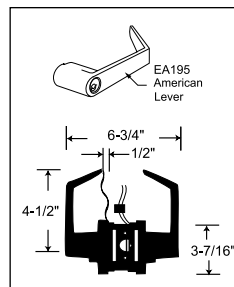

Standard Features

- Backsets: 2-3/4"; 2-3/8", 3-3/4" or 5" optional
- Latch #1834, Front: 1-1/8" x 2-1/4"; Throw: 9/16"; Stainless steel nose
- Levers: Solid cast Zamac w/ 1/2" return (except 395 & 495)
- Rose: Thru-bolted, 3-7/16" dia., spring loaded 2-#10 thru-bolts
- Strike: #1135, 4-7/8" ASA curved lip
- Door thickness: 1-5/8" to 1-7/8" (For 1-3/8" door use K1704 spacer)
- Cylinder: MARKS "C" keyway, 6 pin w/ 2 keys
- Request to Exit Switch: Single pole, double throw, 3 amp, 125 AC, wired either normally open or normally closed
- Electrified functions - 100% duty cycle, 24V/DC standard, supplied with bridge rectifier; 3 watts, .25amps
- 12V/DC Optional, Contact factory for additional options
- Features "The Clutch" • UL Listed, 3 hour fire rating

LOCKSET & LEVER DESIGN	CON. CORE	IC CORE	FUNCTION	ANSI #	DESCRIPTION	FINISH GROUPS	
						26D	3, 4, 10, 10B, 26
EA195 American lever	F	RF	STOREROOM	F86	Latch by lever inside. Outside lever always locked.	617	701
EA295 Crescent lever							
EA395 Monaco lever							
EA495 Titan lever							
EA195 American lever	FEL	RFEL	ELECTRICALLY LOCKED	—	Outside always locked electrically. Open by key outside, switch or loss of power. Latch by lever inside.	848	912
EA295 Crescent lever							
EA395 Monaco lever							
EA495 Titan lever							
EA195 American lever	FEU	RFEU	ELECTRICALLY UNLOCKED	—	Outside always locked until unlocked by key or electrically energized. Latch by lever inside.	848	912
EA295 Crescent lever							
EA395 Monaco lever							
EA495 Titan lever							

LEVERSETS ARE PACKED 6 PER CASE

* Standard IC Core Models: Interchangeable Core models for 6 or 7 pin cores (not included). Accepts: Marks, Medeco KeyMark™, Falcon & Best®. IC Core Tailpieces ARE Included.



Electrified Locksets

How To Order Example for REX Leversets

EA195	F	/	26D	—	G3
1. Lockset Series	2. Marks Function	Slash	3. Finish	Dash	4. Options

LOCK SERIES

- EA195
- EA295
- EA395
- EA495

MARKS FUNCTION

- ___ F ___ RFEL
- ___ RF ___ FEU
- ___ FEL ___ RFEU

FINISH

- 3 4
- 10 10B
- 26 26D

OPTIONS

ELECTRIFIED LOCKSETS

CYLINDRICAL LEVERSETS & MORTISE LOCKSETS

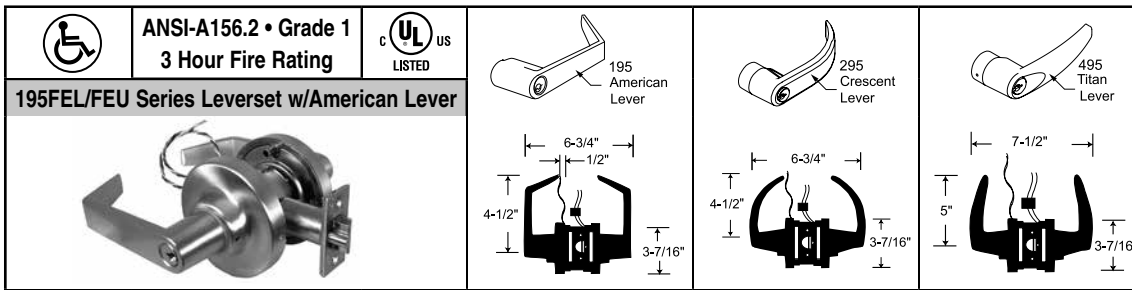

Series 195, 295, 395, 495 Cylindrical Leverset Standard Features

- Backsets: 2-3/4", 2-3/8", 3-3/4", 5"
- Latch #1834, Front: 1-1/8" x 2-1/4"; Throw: 9/16"; Stainless steel nose
- Levers: Solid cast Zamac w/ 1/2" return
- Rose: Thru-bolted, 3-7/16" dia., spring loaded 2-#10 thru-bolts
- Strike: #1135, 4-7/8" ASA curved lip
- Door thickness: 1-5/8" to 1-7/8" (For 1-3/8" door use K1704 spacer)
- Cylinder: MARKS "C" keyway, 6 pin w/ 2 keys or IC Core housing
- Electrified functions - 100% duty cycle, 24V/AC supplied with bridge rectifier; 24V/DC, .21 Amps
- 12V/DC Optional, Contact factory for additional options
- Features "The Clutch"
- UL Listed, 3 hour fire rating

SERIES 195, 295, 395, 495 GRADE 1 ELECTRIFIED CYLINDRICAL LEVERSETS				FINISH GROUPS	
COMMERCIAL CYLINDER	IC CORE CYLINDER	MARKS FUNCTION	DESCRIPTION	3, 26D	4, 10, 10B, 26
FEL	RFEL	ELECTRICALLY LOCKED (Fail Safe)	Outside always locked electrically. Open by key outside, switch or loss of power. Deadlocking latch by lever inside. Lever only.	668	752
FEU	RFEU	ELECTRICALLY UNLOCKED (Fail Secure)	Outside always locked until unlocked by key or electrically energized. Deadlocking latch by lever inside. Lever only.		

* Standard IC Core Models: Accepts: Marks, Medeco KeyMark™, Interchangeable Core models Falcon & Best®. for 6 or 7 pin cores (not included). IC Core Tailpieces ARE Included.



Series 5 Electrified Mortise Lockset Standard Features

- 2-3/4" Backset ONLY
- 1" Stainless steel bolt throw
- 3/4" Latch throw (anti-friction) separator
- 1/2" Auxiliary latch throw
- Stamped steel case .090 thick., Zinc dichromate finish
- 1-1/4" x 8" Lock front, Adjustable bevel
- Steel hubs, 9/32" on diamond, 5/16" on square w/security separator
- 100% Duty Cycle 24V/DC, 12V/DC Optional supplied with bridge rectifier (350 ma)

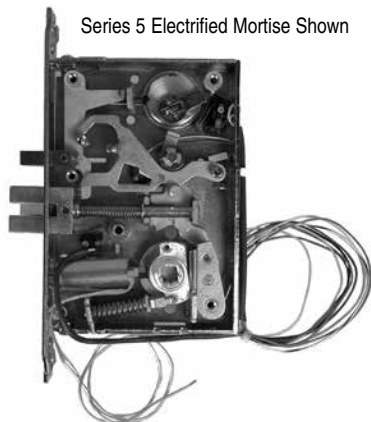

Series 5 Electrified Mortise Shown

OPTIONS	CODE	PRICE
Auxiliary Latch	E3	46
Request to EXit Switch	W10	136
Key Override Sensor	W11	144
Request to EXit switch, Key Sensor & Bolt Sensor	W13	454
Bolt Sensor	W14	166
Latch Sensor	W15	166

SERIES 5 ELECTRIFIED MORTISE LOCKSET			FINISH GROUPS	
MARKS FUNCTION	DESCRIPTION	3, 32D	10, 10B, 32	
EL: ELECTRICALLY LOCKED (Fail Safe)	Outside always locked electrically. Open by key outside, switch or loss of power. Auxiliary latch deadlocks latch. Inside always open.	870*	890*	
EU: ELECTRICALLY UNLOCKED (Fail Secure)	Outside always locked until unlocked by key or electrically energized. Auxiliary latch deadlocks latch. Inside always open.			

* Lock Body Price ONLY. Due to numerous trim and finish options, please refer to the Marks USA Mortise Lockset Price Book.

Electrified Locksets

GATE LOCKS (Reversible)

US PAT.#4,875,725 "NO FALL OUT" FEATURE:
Parts will not fall out when cover is removed.
Replaces Multilock gate locks.

Swinging Gate Locks

Standard Features

- Easily reversible
- Case, cast aluminum 3-5/8" x 6-1/4" x 1"
- Bronze powder coat finish
- Groove: 1/2" wide x 3/16" deep, all sides for wire gate insertion
- 5 pin cylinder(s)
- Lock only, no keeper furnished

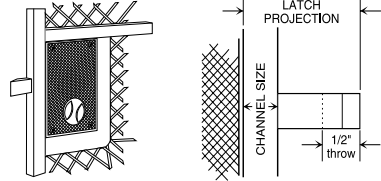

Single
Cylinder Model
*With cylinder
Suffix K
Add \$31

Double
Cylinder Model
*With cylinders
Suffix M
Add \$63

MODEL #	LATCH PROJECTION	CHANNEL SIZE	PRICE LESS CYL.*	WT. / LBS.
W3700	1-1/8"	1/2"	147	20
W3710	1-1/4"	5/8"	147	20
W3720	1-3/8"	3/4"	147	20
W3730	1-7/8"	1-1/4"	165	20
W3750	1-1/8"	1/2"	207	21
W3760	1-1/4"	5/8"	207	21
W3770	1-3/8"	3/4"	207	21
W3780	1-7/8"	1-1/4"	228	21

GATE LOCKS ARE PACKED 12 PER CASE

Sliding Gate Locks

Standard Features

- Easily reversible
- Case, cast aluminum 3-5/8" x 6-1/4" x 1"
- Bronze powder coat finish
- Groove: 1/2" wide x 3/16" deep, all sides for wire gate insertion
- 5 pin cylinder(s)
- Lock only, no keeper furnished

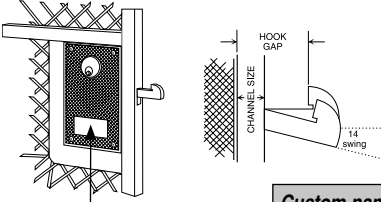

Single
Cylinder Model
*With cylinder
Suffix K
Add \$31

Double
Cylinder Model
*With cylinders
Suffix M
Add \$63

MODEL #	HOOK GAP	CHANNEL SIZE	PRICE LESS CYL.*	WT. / LBS.
W3800	.825"	1/2"	147	21
W3810	.950"	5/8"	147	22
W3820	1.075"	3/4"	147	21
W3830	1.625"	1-1/4"	165	22
W3850	.825"	1/2"	207	22
W3860	.950"	5/8"	207	22
W3870	1.075"	3/4"	207	22
W3880	1.625"	1-1/4"	228	22

GATE LOCKS ARE PACKED 12 PER CASE

Custom nameplate available.
Consult factory.

Parts

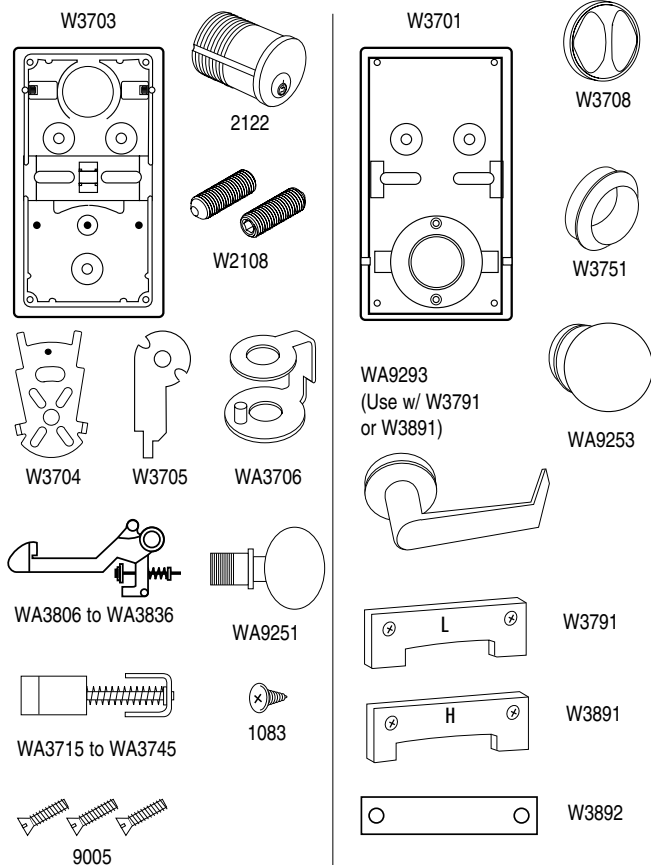

PART #	DESCRIPTION	PRICE
1083	Retainer/fork screw	.61
2122	Mortise cylinder	43
W2108	Cylinder set screw	.61
9005	Case screw	.61
W3701	Cover	43
W3703	Case	67
W3704	Fork	8
W3705	Latch lever	7
W3708	Turnpiece	22
W3751	Double cylinder collar with set screw	43
W3791	Lever stop plate - Swinging gate lock (w/W3892)	14
W3891	Lever stop plate - Sliding gate lock (w/W3892)	14
W3892	Lever slide cover	5
WA3706	Latch adapter	14
WA3715	Latch assembly - 1-1/8" projection	32
WA3725	Latch assembly - 1-1/4" projection	32
WA3735	Latch assembly - 1-3/8" projection	32
WA3745	Latch assembly - 1-7/8" projection	43
WA3806	Hook assembly - .825" gap	43
WA3816	Hook assembly - .950" gap	43
WA3826	Hook assembly - 1.075" gap	43
WA3836	Hook assembly - 1.625" gap	53
WA9251	Exterior knob assembly	87
WA9253	Interior knob assembly	87
WA9293	Interior lever assembly (with W3791 & W3891)	129

SERIES HA113 CUSTOM LOCK DIVISION

HOUSING AUTHORITY MORTISE LOCKSET

SERIES HA113			BHMA CERTIFIED
			FINISH GROUPS
MARKS #	FUNCTION	ANSI #	20A
KEYED SINGLE CYLINDER, NO DEADBOLT			
D	OFFICE VESTIBULE		561
DW	VESTIBULE		
E	OFFICE	F04	
EW	STOREROOM	F07	
GL	INST. PRIVACY	F26	
J	CLASSROOM	F05	
JM, JR	HOSPITAL (HOLDBACK)	F06	
EL	ELECTRICALLY LOCKED		1118
EU	ELECTRICALLY UNLOCKED		
KEYED SINGLE CYLINDER, WITH DEADBOLT			
A	ENTRANCE	F08, F10	576
B	ENTRANCE	F21	
F	DORMITORY	F12	
FS	DORMITORY		
FW	DORMITORY	F13	
FD	APARTMENT	F20	617
H	HOTEL	F15	
LH	SPEC. PRIVACY		
KEYED DOUBLE CYLINDER, NO DEADBOLT			
G	ENTRANCE	F09	617
GC	INTRUDER LATCHBOLT	F32	
GG	CLASSROOM SECURITY		
GR	CLASSROOM SECURITY w/HOLDBACK		
WW	INSTITUTION	F30	
KEYED DOUBLE CYLINDER, WITH DEADBOLT			
AC	ENTRANCE	F35	617
C	STOREROOM	F14	
FC	INTRUDER DEADBOLT	F34	
FA	DORMITORY	F11	
FX	DORMITORY	F33	
KEYLESS			
N	PASSAGE	F01	490
L	BATHROOM	F02	543
LF	PRIVACY	F19	
LJ	PRIVACY	F22	596
EX	EXIT	F31	561

For pricing, finishes and availability, consult factory

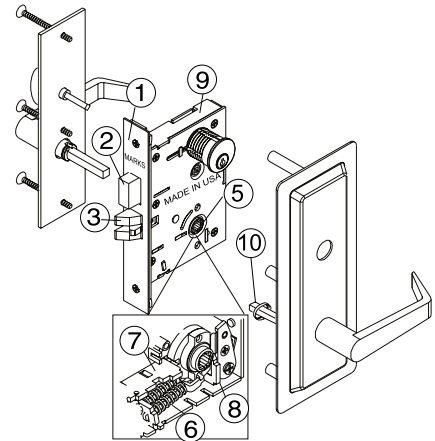

Performance Specifications:

Life Test: 1,500,000 cycles minimum.

ANSI Test: Meets or exceeds all operational and security tests of ANSI specifications A156.13-2005 for series 1000, Grade 1.

Fire Test: UL Listed, 3 hour fire rated.
Meets ADA requirements.



Trim Specifications:

"Barrier" Thru-bolted steel lever/plate assemblies with brass machined lever bearings. Screwless forged American levers, 4-1/2" long to meet ADA requirements, fastened to plates with hardened snap rings. Spring loaded 5/16" spindles (no set screws). Dark bronze powder coated finish.

Exterior: Wrought steel lever/plate assembly.

10-1/8" x 4" x 5/64" with 3 concealed welded thru-posts. Center post braces lock body for proper alignment in 1-3/4" thick door. Plate covers cylinder with only the keyway exposed.

Optional Exterior: Plate prepared for IC core cylinder.

Interior: Flat steel lever/plate assembly. 10-3/4" x 3-1/8" x 3/32" thick with 3 each 1/4"-20 mounting bolts. Center bolt passes through lock body to integrate trim with lock.

Cylinder: 1-1/8" long, 6 pin, solid brass with spacing collar concealed under exterior "Barrier" plate; 2 keys.

Strike: 4-7/8" x 1-1/4" x 3/32" thick, 5/8" curved lip. Conforms to ANSI spec., A115.1.

Door Thickness: 1-3/4" standard. Extended range available.

Lock Specifications: 5 Series (2-3/4" Backset)

- Lock Front:** Adjustable bevel steel backplate 1-1/4" x 8" x 7/64" thick. Cover plate 1/16" thick.
- Deadbolt:** Stainless steel w/hardened roll pins, 1" throw.
- Latch:** Solid stainless steel with antifriction latch lever, 3/4" throw (reversible).
- Auxiliary deadlatch:** 1/2" throw (reversible) - (not shown).
- Hubs:** Steel, 9/32" on diamond, 5/16" on square w/security separator.
- Independent exterior and interior lever support springs.
- Hub Follower:** (to lock hub) steel 1/8" thick.
- Hub Stop:** (to limit lever travel) steel 1/8" thick.
- Case:** Stamped steel 3/32" thick, zinc dichromate finish.
- Spindles:** Independent spring-loaded spindles, 5/16" square.

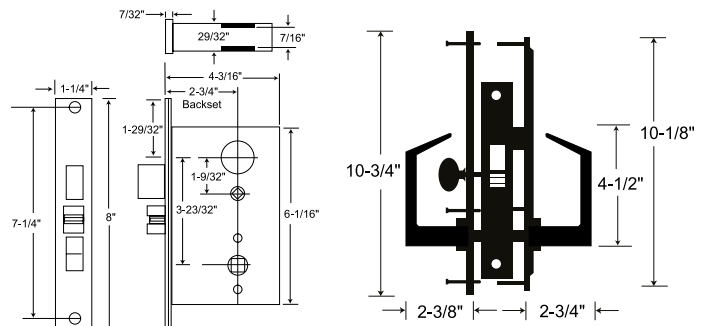

CUSTOM LOCK DIVISION

MAXIMUM SECURITY MORTISE LOCKSET

Series LA318GJ



PERFORMANCE SPECIFICATIONS:

LIFE TEST: 1,500,000 cycles, minimum

STRENGTH TEST: 530 inch lbs. torque on exterior lever. When applied, lockset remains locked. (Torque of over 550 inch lbs. will cause spindle failure. However, lockset remains locked once spindle is replaced, lockset is fully operational.)

ANSI TEST: Certified to meet or exceed all operational and security tests of ANSI/BHMA A156.13-2012 for series 1000, Grade 1

FIRE TEST: UL listed, 3 hour fire rated. Meets ADA requirements.



WARRANTY: Lifetime mechanical limited warranty

All other functions available with latch, deadlatch and deadbolt combinations

FUNCTION SPECIFICATION: LA318GJ CLASSROOM INTRUDER

Latch by lever either side except when outside lever is locked from inside or outside by key. When locked, exterior key will retract latchbolt. Outside key locks or unlocks exterior lever. Inside key is single acting in one direction and will lock exterior lever only; will not unlock exterior lever. Auxiliary latch deadlocks latch. Inside always free for egress

TRIM: Cast satin stainless steel escutcheon 8-1/2"x2-3/4"x7/16". Recess in escutcheon to accept cylinder with rotating security cylinder ring. Cast screwless satin stainless steel lever handles to within 1/2" from face of door secured to escutcheon plate with hardened steel retainer ring. Lever handle, with spring-loaded torque sensitive 5/16" spindle. Integral torque override preventer recessed into escutcheon plate. Spindle will yield if excessive torque applied, preventing any damage to lock body.

EXTERIOR: Two 1/4" diameter threaded thru posts.

Two 1/4" diameter center posts pass thru lock body, automatically aligning trim.

INTERIOR: Two #10-32 phillips head stainless steel mounting thru bolts. Escutcheon with "LOCK" and directional arrow engraved and black filled near cylinder location. Occupancy indicator recessed into escutcheon plate. Indicator window to display unlocked (green day-glo) and LocDown™ (red day-glo) positions.

CYLINDERS: Two 1-1/8", 6-pin solid brass with 2101 cam int., 2105 cam ext., with two keys. Outside cylinder rotates in both directions. Inside cylinder rotates in one direction only. Cams supplied to accommodate Corbin™, Sargent™ and Schlage™ cylinders.

STRIKE: 4-7/8" X 1-1/4" X 3/32" thick, 5/8" curved lip.

Conforms to ANSI spec. 115.1.

DOOR THICKNESS: 1-3/4"

Lock Body: 5 series "GJ" function double cylinder lock. Lock handing completely reversible without opening lock case.

1. Lock Front – Adjustable bevel steel backplate 1 1/4" x 8 x 7/64" thick. Cover plate 1/16" thick, with phillips screws
2. Latch – solid stainless steel w/ antifriction latch lever 3/4" throw
3. Auxiliary Deadlatch – 1/2" throw
4. Case – stamped steel 3/32" thick
5. Hubs – Steel, 9/32" on diamond, 5/16" on square w/ security separator
6. Independent exterior and interior lever support springs

LA318			FINISH GROUPS
MARKS #	FUNCTION	ANSI #	32D
KEYED SINGLE CYLINDER, NO DEADBOLT			
D	OFFICE VESTIBULE		830
DW	VESTIBULE		
E	OFFICE	F04	
EW	STOREROOM	F07	
GL	INST. PRIVACY	F26	
J	CLASSROOM	F05	
JM, JR	HOSPITAL (HOLDBACK)	F06	1143
EL	ELECTRICALLY LOCKED		
EU	ELECTRICALLY UNLOCKED		
KEYED SINGLE CYLINDER, WITH DEADBOLT			
A	ENTRANCE	F08, F10	844
B	ENTRANCE	F21	
F	DORMITORY	F12	
FS	DORMITORY		
FW	DORMITORY	F13	
FD	APARTMENT	F20	866
H	HOTEL	F15	
LH	SPEC. PRIVACY		
KEYED DOUBLE CYLINDER, NO DEADBOLT			
G	ENTRANCE	F09	876
GC	INTRUDER LATCHBOLT	F32	
GG	CLASSROOM SECURITY		
GR	CLASSROOM SECURITY w/HOLDBACK		
WW	INSTITUTION	F30	900
GJ	CLASSROOM SECURITY		
KEYED DOUBLE CYLINDER, WITH DEADBOLT			
AC	ENTRANCE	F35	890
C	STOREROOM	F14	
FC	INTRUDER DEADBOLT	F34	
FA	DORMITORY	F11	
FX	DORMITORY	F33	
KEYLESS			
N	PASSAGE	F01	876
L	BATHROOM	F02	733
LF	PRIVACY	F19	
LJ	PRIVACY	F22	844
EX	EXIT	F31	789
DUMMY TRIM			
DI, DO	DUMMY TRIM INSIDE/OUTSIDE		373
DT	DUMMY TRIM		747

For pricing, finishes and availability, consult factory

MARKS #	FUNCTION	List Price 32D
GJ	Classroom Security w/ Indicator Engraving	\$890
OPTIONS		Code Price
Less Cylinders		G3 -\$30
IC Core Housing		G1 N/C

HOW TO ORDER

Series Function / Finish Option
LA318 GJ / 32D - G3

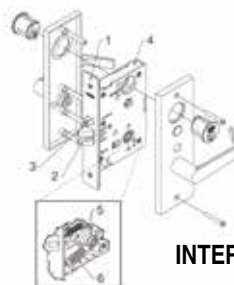

INTERIOR TRIM

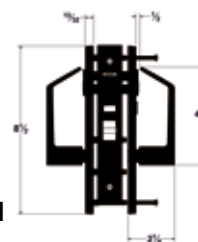

Custom Locksets

SERIES BE101 & LA118 CUSTOM LOCK DIVISION

MAXIMUM SECURITY MORTISE LOCKSET

SERIES BE101 & LA118			BHMA CERTIFIED	
			FINISH GROUPS	
MARKS #	FUNCTION	ANSI #	32D	3, 10, 10B
KEYED SINGLE CYLINDER, NO DEADBOLT				
D	OFFICE VESTIBULE		780	814
DW	VESTIBULE			
E	OFFICE	F04		
EW	STOREROOM	F07		
GL	INST. PRIVACY	F26		
J	CLASSROOM	F05		
JM, JR	HOSPITAL (HOLDBACK)	F06		
EL	ELECTRICALLY LOCKED		1109	1193
EU	ELECTRICALLY UNLOCKED			
KEYED SINGLE CYLINDER, WITH DEADBOLT				
A	ENTRANCE	F08, F10	794	830
B	ENTRANCE	F21		
F	DORMITORY	F12		
FS	DORMITORY			
FW	DORMITORY	F13		
FD	APARTMENT	F20	817	853
H	HOTEL	F15		
LH	SPEC. PRIVACY			
KEYED DOUBLE CYLINDER, NO DEADBOLT				
G	ENTRANCE	F09	828	861
GC	INTRUDER LATCHBOLT	F32		
GG	CLASSROOM SECURITY			
GR	CLASSROOM SECURITY w/HOLDBACK			
WW	INSTITUTION	F30		
KEYED DOUBLE CYLINDER, WITH DEADBOLT				
AC	ENTRANCE	F35	828	861
C	STOREROOM	F14		
FC	INTRUDER DEADBOLT	F34		
FA	DORMITORY	F11		
FX	DORMITORY	F33		
KEYLESS				
N	PASSAGE	F01	677	710
L	BATHROOM	F02	794	830
LF	PRIVACY	F19		
LJ	PRIVACY	F22	735	770
EX	EXIT	F31	735	770
DUMMY TRIM				
DI, DO	DUMMY TRIM INSIDE/OUTSIDE		342	359
DT	DUMMY TRIM		684	770

For pricing, finishes and availability, consult factory

OPTIONS	CODE	PRICE
BE 1-1/2" thick for adapter plate	A19	78
Spacer kit for 1-1/2" thick door	K9311	78

2 Spacer kits are needed

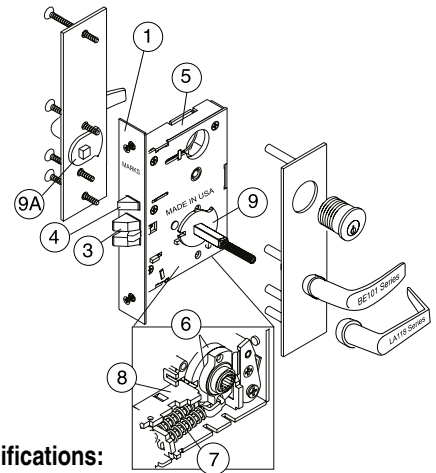

Performance Specifications:

Life Test: 1,500,000 cycles minimum.

ANSI Test: Meets or exceeds all operational and security tests of ANSI specifications A156.13-2005 for series 1000, Grade 1.

Fire Test: UL Listed, 3 hour fire rated.

Meets ADA requirements.



Trim Specifications:

"Barrier" Thru-bolted steel lever/plate assemblies with brass machined lever bearings. Screwless forged American levers, 4-1/2" long to meet ADA requirements, fastened to plates with hardened snap rings. Spring loaded 5/16" spindles (no set screws). Dark bronze powder coated finish.

Exterior: Wrought steel lever/plate assembly.

10-1/8" x 4" x 5/64" with 3 concealed welded thru-posts. Center post braces lock body for proper alignment in 1-3/4" thick door. Plate covers cylinder with only the keyway exposed.

Optional Exterior: Plate prepared for IC core cylinder.

Interior: Flat steel lever/plate assembly. 10-3/4" x 3-1/8" x 3/32" thick with 3 each 1/4"-20 mounting bolts. Center bolt passes through lock body to integrate trim with lock.

Cylinder: 1-1/8" long, 6 pin, solid brass with spacing collar concealed under exterior "Barrier" plate; 2 keys.

Strike: 4-7/8" x 1-1/4" x 3/32" thick, 5/8" curved lip. Conforms to ANSI spec., A115.1.



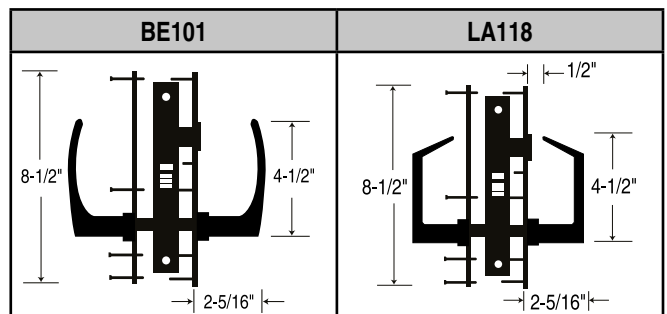

Door Thickness: 1-3/4" standard. Extended range available.

Lock Specifications: 5 Series (2-3/4" Backset)

- Lock Front:** Adjustable bevel steel backplate 1-1/4" x 8" x 7/64" thick. Cover plate 1/16" thick.
- Deadbolt:** Stainless steel w/hardened roll pins, 1" throw.
- Latch:** Solid stainless steel with antifriction latch lever, 3/4" throw (reversible).
- Auxiliary deadlatch:** 1/2" throw (reversible) - (not shown).
- Hubs:** Steel, 9/32" on diamond, 5/16" on square w/security separator.
- Independent exterior and interior lever support springs.
- Hub Follower:** (to lock hub) steel 1/8" thick.
- Hub Stop:** (to limit lever travel) steel 1/8" thick.
- Case:** Stamped steel 3/32" thick, zinc dichromate finish.
- Spindles:** Independent spring-loaded spindles, 5/16" square.

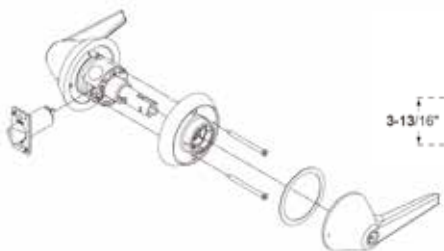

GRADE 1 195SS LifeSaver™ CYLINDRICAL LEVERSETS

		ANSI-A156.2 • Grade 1 3 Hour Fire Rating		195SS SERIES	
195SS Series Leversets Shown Below			Standard Features		
 			<ul style="list-style-type: none"> • ANSI-A156.2 Grade 1, UL listed 3 Hr. Fire Rating • Backset: 2-3/4" Standard, 2-3/8", 3-3/4", 5" Available • Latch #1834, stainless steel nose • Levers: Solid cast stainless steel. Levers Rotate up & down freely in locked or unlocked position • Levers recessed into solid stainless steel roses eliminating any open gap • Roses: Thru-bolted, spring loaded, #10 thru-bolts • Strike: #1135, 4-7/8" ASA curved lip strike • Door thickness: 1-3/4" +/- 1/16" • Cylinder: MARKS "C" keyway, 6 pin w/ 2 keys 		
SERIES 1SS19					
MARKS #		DESCRIPTION	ANSI #	FINISH	PRICE
COMM. CYL.	ACCEPTS IC CORE CYL.*				
N	—	PASSAGE	F75	32D	814
L	—	PRIVACY	F76		835
LK	—	PRIVACY	F76 MOD.		861
P	—	PATIO	F77		830
DC	RDC	COMMUNICATING	F80		893
A	RA	ENTRY	F81		851
B	RB	ENTRY	F82A		851
AB	RAB	ENTRANCE	F109		851
AQ	—	EXIT	F83		840
S	RS	CLASSROOM	F84		851
F	RF	STOREROOM	F86		851
DW	RDW	INSTITUTION	F87		893
DA	RDA	VESTIBULE	F88		893
FQ	—	EXIT	F89		840
T	—	CORRIDOR	F90		861
TK	—	HOSPITAL/PRIV.	F90 MOD.		830
GB	RGB	STORE DOOR	F91		861
BS	RBS	SVC. STATION LOCK	F92		903
DO	—	DUMMY TRIM OUTSIDE	—		672
DT	—	FULL DUMMY TRIM	—		772
NB	—	COMM. PASSAGE	F111	793	
FB	RFB	COMM. STOREROOM	F112	845	
SB	RSB	COMM. CLASSROOM	F113	845	
FEL	RFEL	ELECTRICALLY LOCKED		1019	
FEU	RFEU	ELECTRICALLY UNLOCKED		1019	
PACKED 6 PER CASE					

OPTIONS	CODE	PRICE	OPTIONS	CODE	PRICE
For 2" doors	D1	50	Sargent conventional cylinder	F8	23
For 2-1/4" doors, Consult Factory	D2		Corbin conventional cylinder	F9	23
Over 2-1/4" - 4" thickness	D9	648	Corbin 6 pin IC core	F12	34
2-3/8" backset, 1" x 2-1/4" face	E6	NC	Yale 6 pin IC core	F14	23
5" backset, 9/16" throw, Gr. 1	E9	47	Sargent IC core	F20	23
3-3/4" backset, 9/16" throw, Gr. 1	E10	47	Medeco IC core large format	F21	23
Less cylinder	G3	Deduct 15			
2-3/4" "T" strike	S3	NC			

How To Order					
195SS	F	/	32D	—	G3
1. Lockset Series	2. Marks Function	Slash	3. Finish	Dash	4. Options

★ **Standard & HI-SECURITY™ IC Core Models:** Interchangeable Core models for 6 or 7 pin cores (not included). **Accepts:** Marks, Marks HI-SECURITY™, Medeco®, KeyMark™, Falcon, Schlage® small format & Best®. **IC Core Tailpieces ARE Included.**





Antimicrobial Finish Available
Option Code: AM

Institutional Life Safety

SERIES 5SS55 KNOB & 5SS19 LEVER

INSTITUTIONAL LifeSaver™ MORTISE LOCKSETS

		SERIES 5				FINISH 32D	
MARKS #	FUNCTION	ANSI #	SS55 Knob	SS19 Lever			
KEYED SINGLE CYLINDER, NO DEADBOLT							
D	OFFICE VEST.		1066	1066			
DW	VESTIBULE						
E	OFFICE	F04					
EW	STOREROOM	F07					
J	CLASSROOM	F05					
GL	INSTIT. PRIVACY	F26					
EL	ELECTRICALLY LOCKED		1377	1377			
EU	ELECTRICALLY UNLOCKED						
KEYED SINGLE CYLINDER, WITH DEADBOLT							
A	ENTRANCE	F08, F10	1239	1239			
B	ENTRANCE	F21					
F	DORMITORY	F12					
FS	DORMITORY						
FW	DORMITORY	F13					
KEYED DOUBLE CYLINDER, NO DEADBOLT							
G	APARTMENT	F09	1095	1095			
GC	INTRUDER LATCHBOLT	F32					
GG	CLASSROOM SECURITY						
WW	INSTITUTIONAL	F30					
KEYED DOUBLE CYLINDER, WITH DEADBOLT							
AC	ENTRANCE	F35	1095	1095			
C	STOREROOM	F14					
FA	DORMITORY	F11					
FX	DORMITORY	F33					
KEYLESS							
N	PASSAGE	F01	1027	1027			
L	BATHROOM	F02	1221	1221			
LF	PRIVACY	F19					
LJ	PRIVACY	F22	1250	1250			
EX	EXIT	F31					
DUMMY TRIM							
DI	DUMMY TRIM INSIDE		567	567			
DO	DUMMY TRIM OUTSIDE						
DT	FULLY DUMMY		1131	1131			

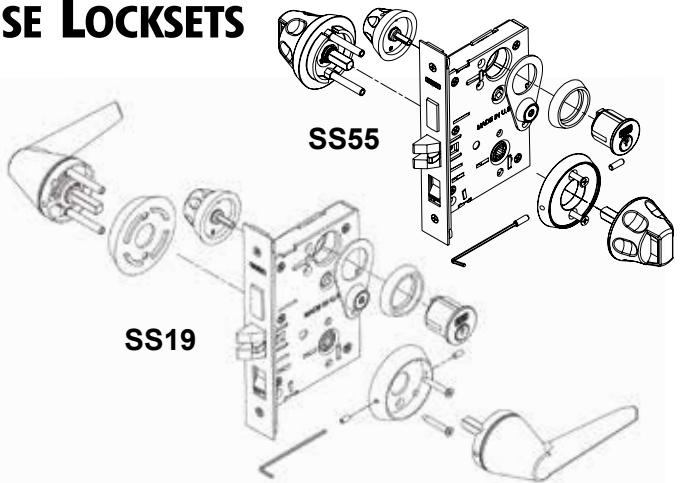

Performance Specifications:

Life Test: 1,500,000 cycles minimum.

ANSI Test: Meets or exceeds all operational and security tests of ANSI specifications A156.13-2005 for series 5000, Grade 1.

Trim Specifications:

Exterior & Interior Trim:

- Solid stainless steel interior and exterior tapered knobs or levers recessed into thru-bolted roses.
- Safety knobs with recessed grip and finger indents (*Patent #D587556*).
- Safety lever for handicapped access on clutch operated Mortise lock.
- Ergonomically designed grooved turn knob for deadbolt functions.

Cylinder: Solid stainless steel cylinders with solid stainless steel security collars; Optional HI-SECURITY™ cylinders available

Strike: 4-7/8" curved lip stainless steel w/tamperproof screws

Door Thickness: 1-3/4" standard; Extended range available

Door Prep: ANSI A115.1 lock face cutout, with 2-1/8" through hole for knob/rose assembly

Lock Specifications: 5 Series (2-3/4" Backset) 55 Series (2-1/2" Backset)

Lock Front: Adjustable bevel steel backplate 1-1/4" x 8" x 7/64" thick, Cover plate 1/16" thick with tamper proof screws

Latch: Solid stainless steel with antifinger latch lever, 3/4" throw (reversible)

Levers: Solid cast stainless steel. **Levers Rotate up & down freely in locked or unlocked position**

Aux. Deadlatch: 1/2" throw, (reversible)

Case: Stamped steel 3/32" thick, zinc dichromate finish

Hubs: Steel, 9/32" on diamond, 5/16" on square w/security separator

Hub Lock Arm: (to lock hub) Steel 1/8" thick

Spindles: Independent spring-loaded spindles

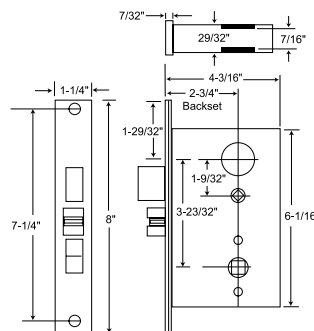

Antimicrobial Finish Available
Option Code: AM

Quick Privacy Access
A9618-1 Shown;
Option Code A25



★ **Standard & HI-SECURITY™ IC Core Models:** 
Interchangeable Core models for 6 or 7 pin cores (not included).
Accepts: Marks, Marks HI-SECURITY™, Medeco®, KeyMark™, Falcon, Schlage® small format & Best®. **IC Core Tailpieces ARE Included.**

How To Order						
5SS55 Knob	5SS19 Lever	J	/	32D	—	G3
1. Lockset Series	2. Marks Function	3. Slash	4. Dash	5. Finish	6. Options	

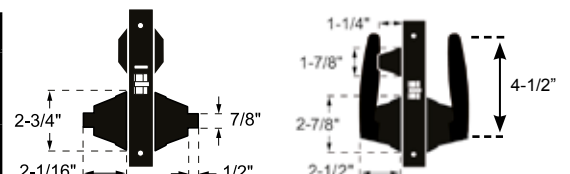

Institutional Life Safety

SERIES 180SS INSTITUTIONAL LifeSaver™ LOCKSETS

INSTITUTIONAL LIFE SAFETY CYLINDRICAL KNOBSETS & LOCKSETS

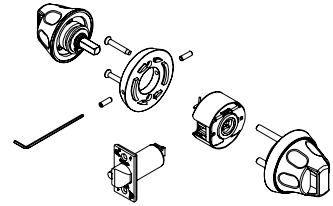

SERIES 180SS			FINISH GROUPS
MARKS #	FUNCTION	ANSI #	32D
KEYED SINGLE CYLINDER, WITH DEADBOLT			
K	CYLINDER x KNOB	E0121	1073
KEYLESS			
N	PASSAGE	F75	1042

★ **Standard & HI-SECURITY™ IC Core Models:** 
 Interchangeable Core models for 6 or 7 pin cores (not included).
Accepts: Marks, Marks HI-SECURITY™, Medeco®, KeyMark™, Falcon, Schlage® small format & Best®. **IC Core Tailpieces ARE Included.**

180SSK: Function E0121; Latch by knob inside, key outside.

180SSN: Function F75; Latch by knob either side, always open.

Antimicrobial Finish Available
Option Code: AM

Performance Specifications

- Life Test:** 1,500,000 cycles minimum.
- ANSI Test:** Meets or exceeds all operational and security tests of ANSI specifications A156.2-2003 for series 1000, Grade 1.

Fire Test: UL Listed, 3 Hour fire rated. 

Exterior & Interior Trim:

- Solid stainless steel interior and exterior tapered knobs recessed into thru-bolted roses
- Specially designed finger indented safety knobs with recessed grip and ergonomically designed integral grooved turn knob for elderly and handicapped access (*Patent #D587556*)
- Needle bearings ensure smoothness of operation

1SS55K Cylindrical Deadlatch Lockset: ANSI E0121 Cylinder x Knob

- Strike:** #1136, 2-3/4" "T" strike; #1135 4-7/8" ASA strike optional
- Door Prep:** ANSI 115.2
- Latch:** ANSI 156.2, Grade 1, 3 Hour fire rated
- Door Thickness:** 1-3/4"
- Backset:** 2-3/4" Backset; 3-3/4" and 5" backsets also available
- Latch Face:** 1-1/8" x 2-1/4" with tamper proof screws
- Cylinder:** Solid brass cylinder, 6-pin, "C" keyway; Optional HI-SECURITY™ cylinders available

1SS55N Cylindrical Lockset: ANSI F75 Passage

- Strike:** #1136, 2-3/4" "T" strike
- Door Prep:** ANSI 115.2
- Latch:** ANSI 156.2, Grade 1, 3 Hour fire rated
- Backset:** 2-3/4" backset standard, 2-3/8" backset optional; 3-3/4" and 5" backsets also available
- Latch Face:** 1-1/8" x 2-1/4" with tamper proof screws
- Latch Throw:** 9/16"

SERIES 31SS55 INSTITUTIONAL LifeSaver™ LOCKSETS

INSTITUTIONAL LIFE SAFETY MORTISE DEADLOCK

SERIES 31SS55			 FINISH GROUPS
MARKS #	FUNCTION	ANSI #	32D
KEYED SINGLE CYLINDER, WITH DEADBOLT			
K	CYLINDER x KNOB	E06071	447
S	CLASSROOM	E06091	476

31SS55K: Function E06071; Deadbolt by outside key. Interior safety knob will retract but not project deadbolt.

31SS55S: Function E06091; Deadbolt by outside key. Turnpiece will retract but not project deadbolt.

Performance Specifications:

- Life Test:** 1,500,000 cycles minimum.
- ANSI Test:** Meets or exceeds all operational and security tests of ANSI/BHMA Certified A156.5-2001 for series 31, Grade 1.

Fire Test: UL Listed, 3 Hour fire rated. 

Trim Specifications:

Interior Trim: Solid stainless steel interior trim including finger indented safety knobs which recess into solid brass through-bolted roses.

Series 31 Deadlock Specifications:

- Backset:** 2-3/4"
- Bolt throw:** 1" stainless steel w/hardened roll pins
- Case:** Stamped Steel
- Front:** 1-1/16" x 4-5/8" adjustable bevel
- Cylinder:** Solid brass cylinder, 6-pin, "C" keyway, 2 keys. Optional HI-SECURITY™ cylinders available.
- Strike:** #4035 Included

Antimicrobial Finish
Option Code: AM

★ **Standard & HI-SECURITY™ IC Core Models:** 
 Interchangeable Core models for 6 or 7 pin cores (not included).
Accepts: Marks, Marks HI-SECURITY™, Medeco®, KeyMark™, Falcon, Schlage® small format & Best®. **IC Core Tailpieces ARE Included.**

SERIES 180PD & 5PD HOSPITAL LifeSaver™ LOCKSETS

CYLINDRICAL & MORTISE PUSH/PULL PADDLESETS

Hospital Push/Pull Standard Features			
• 1-3/4" door thickness, self adjusting for thicker doors		• Non-Handed	
• Variable mounting positions		• Easily reversible configuration for push or pull styles	
180PD Cylindrical Standard Features		SERIES 180PD • ANSI-A156.2 • Grade 1	
• 2-3/4" backset std., 2-3/8", 3-3/4" & 5" optional			LEAD LINING & ENGRAVING AVAILABLE
• 2-3/4" "T" strike; 4-7/8" ASA strike optional			
• Government standard #161 door prep			
MARKS #	FUNCTION	ANSI #	FINISH: 32D Standard Consult Factory for Additional Finishes
N	PASSAGE	F75	318
PUSH/PULLS ARE PACKED 6 PER CASE			

5PD, 55PD Mortise Standard Features		SERIES 5PD, 55PD • ANSI-A156.13 • Grade 1	
• 5 Series Backset: 2-3/4"; 55 Series Backset: 2-1/2"			LEAD LINING & ENGRAVING AVAILABLE
• Strike: #9035, 4-7/8" ASA curved lip strike			
MARKS #	FUNCTION	ANSI #	FINISH: 32D Standard Consult Factory for Additional Finishes

KEYED SINGLE CYLINDER, NO DEADBOLT			
D	OFFICE VEST.		
DW	VESTIBULE		
E	OFFICE	F04	
EW	STOREROOM	F07	735
J	CLASSROOM	F05	
JM, JR	HOSPITAL	F06	
GL	INSTITUTIONAL PRIVACY	F26	
EL	ELECTRICALLY LOCKED		
EU	ELECTRICALLY UNLOCKED		1064
KEYED SINGLE CYLINDER, WITH DEADBOLT			
A	ENTRANCE	F08, F10	
B	ENTRANCE	F21	
F	DORMITORY	F12	750
FS	DORMITORY		
FW	DORMITORY	F13	
FD	APARTMENT	F20	
H	HOTEL	F15	773
LH	SPECIAL PRIVACY		
KEYED DOUBLE CYLINDER, NO DEADBOLT			
G	APARTMENT	F09	
GC	INTRUDER LATCHBOLT	F32	
GG	CLASSROOM SECURITY		783
GR	CLASSROOM SECURITY w/ HOLDBACK		
WW	INSTITUTIONAL	F30	
KEYED DOUBLE CYLINDER, WITH DEADBOLT			
AC	ENTRANCE	F35	
C	STOREROOM	F14	
FC	INTRUDER DEADBOLT	F34	783
FA	DORMITORY	F11	
FX	DORMITORY	F33	
KEYLESS			
N	PASSAGE	F01	633
L	BATHROOM	F02	
LF	PRIVACY	F19	750
LJ	PRIVACY	F22	
EX	EXIT	F31	688

180PD Cylindrical Paddleset

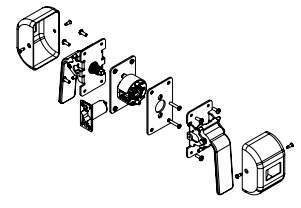
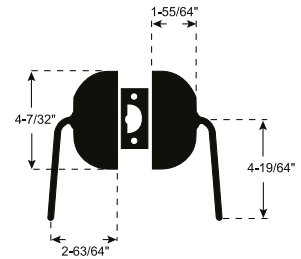

5PD Mortise Paddleset

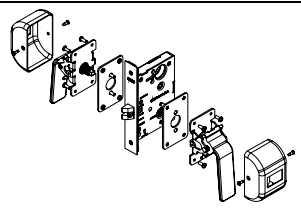
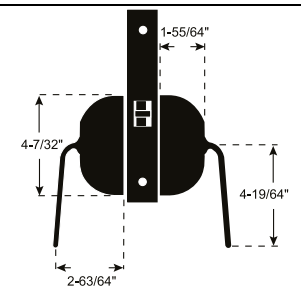

How To Order

5PD or 180PD	F	/	32D	—	G3
1. Lockset Series	2. Marks Function	Slash	3. Finish	Dash	4. Options

MORTISE LOCK CYLINDERS

Cylinders

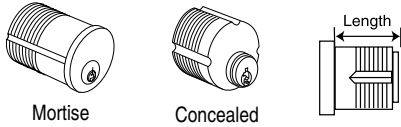

IC Core Cylinder Housings

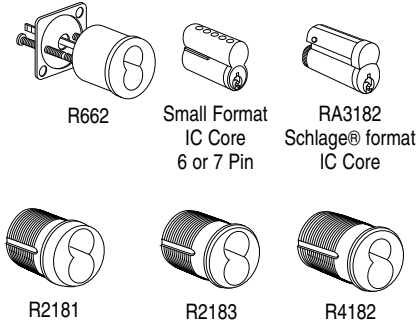

IC core pricing includes KA, KD or MK keying.

*** Standard & HI-SECURITY™ IC Core Models:** 
 Interchangeable Core models for 6 or 7 pin cores (not included).
Accepts: Marks, Marks HI-SECURITY™, Medeco®, KeyMark™, Falcon, Schlage® small format & Best®. **IC Core Tailpieces ARE Included.**

PART #	DESCRIPTION	PINS	LENGTH	FINISH GROUPS		
				3, 26D	5, 10, 10B, 15, 26, 32D	3E
2122	Mortise	5	15/16"	49	51	71
2181	Mortise	6	2-7/8"	422	—	—
2182	Mortise	6	1-1/8"	53	59	74
2183	Mortise	6	1-1/4"	53	59	74
2193	Concealed	5	15/16"	71	—	—
2194	Concealed	6	1-1/8"	75	—	—
2196	Mortise	6	2-3/8"	294	—	—
2197	Mortise	6	1-3/4"	114	119	134
2198	Mortise	6	1-1/2"	91	94	114
662	Rim	6	—	53	59	—
* R2181	Mortise IC Core Housing	6	1"	53	59	—
* R2182	Mortise IC Core Housing	6	1-1/4"	49	51	—
* R2183	Mortise IC Core Housing	6 or 7	1-3/8"	49	51	—
* R2184	IC Core Cylinder Housing	6 or 7	1-3/4"	113	113	113
* R3182	Schlage® type IC Core, Uncombined	6	—	113	—	—
* R4182	Schlage® type IC Core Housing	6	1-1/2"	134	—	—
* R662	Rim IC Core Housing	6 or 7	1-3/8"	56	59	—
* R1182	6 Pin Core, Uncombined	—	—	43	—	—
* R1183	7 Pin Core, Uncombined	—	—	43	—	—
* RA1182	6 Pin Core, Combined	—	—	63	65	—
* RA1183	7 Pin Core, Combined	—	—	63	65	—
* RA3182	Schlage® type IC Core, Combined	6	—	134	—	—
* RC1182	6 Pin Core, Construction Core	—	—	45	—	—
* RC1187	Plastic Core Turn Knob	—	—	8	—	—
* RC3182	Schlage® type Construction Core	—	—	113	—	—
RM1182	Marketry Core	—	—	47	—	—

Cylinder Cams



PART #	DESCRIPTION	USE WITH MORTISE LOCK	CODE	PRICE
2101	STRAIGHT CAM	MARKS	1	6
2101-A		ARROW/SARGENT	A1	6
2101-C		CORBIN RUSSWIN	C1	6
2101-S		SCHLAGE	S1	6
2102		CLOVERLEAF CAM	MARKS	2
2102-A	ARROW/SARGENT		A2	6
2102-C	CORBIN RUSSWIN		C2	6
2102-S	SCHLAGE		S2	6

PART #	DESCRIPTION	USE WITH MORTISE LOCK	CODE	PRICE
2104	ADAMS-RITE CAM	MARKS	4	6
2105	"J" FUNCTION CAM	MARKS	5	6
2105-A		ARROW/SARGENT	A5	6
2105-C		CORBIN RUSSWIN	C5	6
2105-S		SCHLAGE	S5	6
2107-CL		"J-CL" FUNCTION CAM	MARKS	7
2106	"G" CAM Exterior only	MARKS	6	6
2106-A		ARROW/SARGENT	A6	6
2106-C		CORBIN RUSSWIN	C6	6
2106-S		SCHLAGE	S6	6

How To Order Example for Mortise Lock Cylinders

2182	/	32D	—	1C
1. Cylinder	Slash	2. Finish	Dash	3. Options

See List Of
Cylinders
Available

FINISH
(Pg. 8)

- | | | |
|-----------------------------|------------------------------|------------------------------|
| <input type="checkbox"/> 3 | <input type="checkbox"/> 10 | <input type="checkbox"/> 26 |
| <input type="checkbox"/> 3E | <input type="checkbox"/> 10B | <input type="checkbox"/> 26D |
| <input type="checkbox"/> 5 | <input type="checkbox"/> 15 | <input type="checkbox"/> 32D |

Special

Specify

- Keying
- Door Thickness

Cam and keying information
must be included in the option section.

KEYS & KEYING

Keys

Can Stamp A Maximum Of 6 Characters On Key.

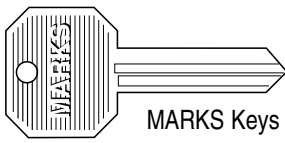

MARKS Keys

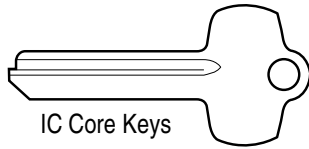

IC Core Keys

STANDARD KEYWAYS	PIN LENGTH ACCEPTS	SHOULDER INCREMENTS	PIN TO PIN TO 1st PIN	PLUG DISTANCE	DIAMETER
MARKS "A"	Arrow Kwikset Segal 9	.015"	.264"	.156"	.504"
MARKS "C"	Schlage "C"	.015"	.231"	.156"	.504"

Construction Master Keying:

The construction master key (CMK) is to be used temporarily while the building is under construction. When construction is completed, the end user defeats the CMK's operation by turning the change key in each cylinder, rather than replace or re-keying the cylinder.

Marks USA uses a program which is called the "lost ball" program. When construction key system is set up, three small ball bearings (construction balls) are placed between the bottom pin and master pin, normally in the last chamber as a "temporary master pin". The construction key is usually the same cut as the top master key with the exception of the sixth cut which is two increments higher. The construction master key will work in any cylinder until cylinder is "defeated" by making one full rotation in the cylinder with the change key. The cylinder plug requires a small diameter "pocket" drilled on one side of one pin chamber so when rotating the cylinder with the change key the pocket will capture the construction balls. The construction pocket in the plug is smaller than a pin chamber. This prevents any top pins or master pins from entering as the plug rotates. Once the cylinder is defeated, there is no way for the cylinder to be construction keyed again without disassembling it.

PART #	DESCRIPTION	PRICE	
		BLANK	CUT
2164A	MARKS "A" 5 PIN BRASS	5	7
2164C	MARKS "C" 5 PIN BRASS, NICKEL PLATED	5	7
2184A	MARKS "A" 6 PIN NICKEL SILVER	6	8
2184C	MARKS "C" 6 PIN NICKEL SILVER	6	6
R1164	IC CORE 6 OR 7 PIN (SMALL FORMAT)	6	8
R3164	SCHLAGE® IC CORE CONTROL KEY	6	8

BEST® A thru M keyway. Please specify.
IC Core pricing includes KA, KD or MK Keying.

PART #	DESCRIPTION	PRICE	
		REGULAR	IC CORE
KA	KEYED ALIKE	NC	NC
KD	KEYED DIFFERENT	NC	NC
MK	MASTER KEYED	21	NC
CMK	CONSTRUCTION MASTER KEYED (Includes GMK or MK)	31	—
GMK	GRAND MASTER KEYED	21	13
GGMK	GREAT GRAND MASTER KEYED	21	13
GGGMK	GREAT GREAT GRAND MASTER KEYED	21	—
HK	HOTEL KEYED (Guest, Maid, Emergency)	28	—
KEYING TO A SPECIFIC CODE NUMBER		15	15
STAMPING		PRICE	
LETTERS/NUMBERS ON KEY		7 PER KEY	
US PROPERTY - "DO NOT DUPLICATE"		7 PER KEY	
VISUAL KEY CONTROL (VKC)		6	
CONCEAL KEY CONTROL		15	
EXTRA CUT KEYS WITH LOCKSET		SEE KEYS ABOVE	
KEY BITTING CODE LIST		252	

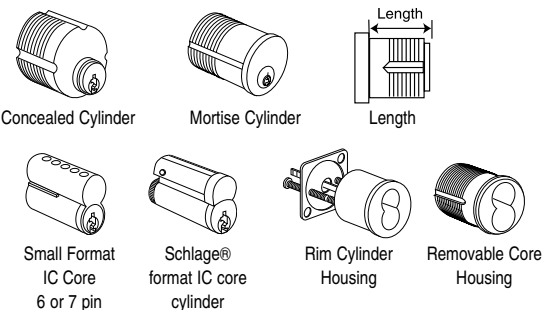
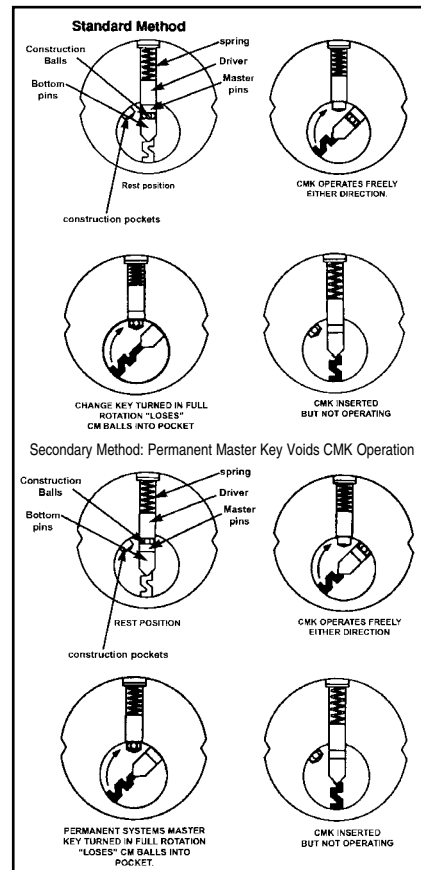

IC CORE PRICING INCLUDES KA, KD OR MK KEYING

*** Standard & HI-SECURITY™ IC Core Models:** Interchangeable Core models for 6 or 7 pin cores (not included).
Accepts: Marks, Marks HI-SECURITY™, Medeco®, KeyMark™, Falcon, Schlage® small format & Best®. IC Core Tailpieces ARE Included.

HI-SECURITY™ CYLINDERS: NON-UL



HI-SECURITY™ MORTISE CYLINDERS						
	NON-UL "0" Bitted x 2 Keys; "0" Bitted "NO KEYS" - Deduct \$6		FINISH GROUPS			
	PART #	DESCRIPTION	3, 26D	4, 5, 10, 10B, 15, 26, 32D	3E	
	BXXX-D001A0N2	1-1/8" Mortise Cylinder	72	78	91	
	CXXX-D001A0N2	1-1/4" Mortise Cylinder	78	84	97	
	DXXX-D001A0N2	1-3/8" Mortise Cylinder	90	95	109	
	LXXX-D001A0N2	1-1/2" Mortise Cylinder	101	106	119	
	MXXX-D001A0N2	1-3/4" Mortise Cylinder	113	120	132	
	NON-UL KD x 2 Keys					
	BXXX-D001A1N2	1-1/8" Mortise Cylinder	79	86	101	
	CXXX-D001A1N2	1-1/4" Mortise Cylinder	86	90	105	

HI-SECURITY™ CYLINDERS ARE PACKED 24 PER CASE

HI-SECURITY™ MORTISE/RIM COMBO CYLINDERS						
	NON-UL "0" Bitted x 2 Keys; "0" Bitted "NO KEYS" - Deduct \$6		FINISH GROUPS			
	PART #	DESCRIPTION	3, 26D	4, 5, 10, 10B, 15, 26, 32D	3E	
	EXXX-D001A0N2	1" Combo Cylinder	65	70	85	
	FXXX-D001A0N2	1-1/8" Combo Cylinder	78	84	97	
	NON-UL KD x 2 Keys					
	EXXX-D001A1N2	1" Combo Cylinder	73	78	91	
	FXXX-D001A1N2	1-1/8" Combo Cylinder	86	90	105	

HI-SECURITY™ CYLINDERS ARE PACKED 24 PER CASE

HI-SECURITY™ KIK CYLINDERS				
	NON-UL "0" Bitted x 2 Keys; "0" Bitted "NO KEYS" - Deduct \$6		FINISH GROUPS	
	PART #	DESCRIPTION	26D	
	G26D-D001X0N2	Key-In-Knob Cylinder	59	
	NON-UL KD x 2 Keys			
	G26D-D001X1N2	Key-In-Knob Cylinder	65	

HI-SECURITY™ CYLINDERS ARE PACKED 24 PER CASE

HI-SECURITY™ MARKS IC CORE CYLINDERS				
	NON-UL "0" Bitted x 2 Keys x 1 Control Key; "0" Bitted "NO KEYS" - Deduct \$6		FINISH GROUPS	
	PART #	DESCRIPTION	26D	
	H26D-D001X0N2	6 Pin IC Core Cylinder	65	
	J26D-D001X0N2	7 Pin IC Core Cylinder	68	
	NON-UL KD x 2 Keys x 1 Control Key			
	H26D-D001X1N2	6 Pin IC Core Cylinder	76	
J26D-D001X1N2	7 Pin IC Core Cylinder	79		

HI-SECURITY™ CYLINDERS ARE PACKED 24 PER CASE

HI-SECURITY™ Schlage® LARGE FORMAT IC CORE CYLINDERS				
	NON-UL "0" Bitted x 2 Keys x 1 Control Key; "0" Bitted "NO KEYS" - Deduct \$6		FINISH GROUPS	
	PART #	DESCRIPTION	26D	
	K26D-D001X0N2	6 Pin Schlage® IC Core Cylinder	83	
	NON-UL KD x 2 Keys x 1 Control Key			
	K26D-D001X1N2	6 Pin Schlage® IC Core Cylinder	92	

HI-SECURITY™ CYLINDERS ARE PACKED 24 PER CASE

HI-SECURITY™ Medeco® LARGE FORMAT IC CORE CYLINDERS			
	NON-UL "0" Bitted x 2 Keys x 1 Control Key; "0" Bitted "NO KEYS" - Deduct \$6		FINISH GROUPS
	PART #	DESCRIPTION	26D
	P26D-D001X0N2	6 Pin Medeco® IC Core Cylinder	101
	NON-UL KD x 2 Keys x 1 Control Key		
P26D-D001X1N2	6 Pin Medeco® IC Core Cylinder	112	

HI-SECURITY™ CYLINDERS ARE PACKED 24 PER CASE

HI-SECURITY™
Cylinders

HI-SECURITY™ CYLINDERS: UL 437



HI-SECURITY™ MORTISE CYLINDERS					
	UL 437 "0" Bitted x 2 Keys; "0" Bitted "NO KEYS" - Deduct \$6		FINISH GROUPS		
	PART #	DESCRIPTION	3, 26D	4, 5, 10, 10B, 15, 26, 32D	3E
	BXXX-D001A0U2	1-1/8" Mortise Cylinder	90	95	109
	CXXX-D001A0U2	1-1/4" Mortise Cylinder	92	98	112
	DXXX-D001A0U2	1-3/8" Mortise Cylinder	108	113	128
	LXXX-D001A0U2	1-1/2" Mortise Cylinder	114	123	137
	MXXX-D001A0U2	1-3/4" Mortise Cylinder	131	135	149
	UL 437 KD x 2 Keys				
	BXXX-D001A1U2	1-1/8" Mortise Cylinder	98	103	117
	CXXX-D001A1U2	1-1/4" Mortise Cylinder	101	107	119
	DXXX-D001A1U2	1-3/8" Mortise Cylinder	116	120	134
	LXXX-D001A1U2	1-1/2" Mortise Cylinder	126	131	145
MXXX-D001A1U2	1-3/4" Mortise Cylinder	138	144	158	

HI-SECURITY™ CYLINDERS ARE PACKED 24 PER CASE

HI-SECURITY™ MORTISE/RIM COMBO CYLINDERS					
	UL 437 "0" Bitted x 2 Keys; "0" Bitted "NO KEYS" - Deduct \$6		FINISH GROUPS		
	PART #	DESCRIPTION	3, 26D	4, 5, 10, 10B, 15, 26, 32D	3E
	EXXX-D001A0U2	1" Combo Cylinder	84	88	102
	FXXX-D001A0U2	1-1/8" Combo Cylinder	95	101	114
	UL 437 KD x 2 Keys				
	EXXX-D001A1U2	1" Combo Cylinder	90	95	109
FXXX-D001A1U2	1-1/8" Combo Cylinder	103	108	109	

HI-SECURITY™ CYLINDERS ARE PACKED 24 PER CASE

HI-SECURITY™ KIK CYLINDERS			
	UL 437 "0" Bitted x 2 Keys; "0" Bitted "NO KEYS" - Deduct \$6		FINISH GROUPS
	PART #	DESCRIPTION	26D
	G26D-D001X0U2	Key-In-Knob Cylinder	75
	UL 437 KD x 2 Keys		
G26D-D001X1U2	Key-In-Knob Cylinder	84	

HI-SECURITY™ CYLINDERS ARE PACKED 24 PER CASE

HI-SECURITY™ Schlage® LARGE FORMAT IC CORE CYLINDERS			
	UL 437 "0" Bitted x 2 Keys x 1 Control Key; "0" Bitted "NO KEYS" - Deduct \$6		FINISH GROUPS
	PART #	DESCRIPTION	26D
	K26D-D001X0U2	6 Pin Schlage® IC Core Cylinder	97
	NON-UL KD x 2 Keys x 1 Control Key		
K26D-D001X1U2	6 Pin Schlage® IC Core Cylinder	108	

HI-SECURITY™ CYLINDERS ARE PACKED 24 PER CASE

HI-SECURITY™ Medeco® LARGE FORMAT IC CORE CYLINDERS			
	UL 437 "0" Bitted x 2 Keys x 1 Control Key; "0" Bitted "NO KEYS" - Deduct \$6		FINISH GROUPS
	PART #	DESCRIPTION	26D
	P26D-D001X0U2	6 Pin Medeco® IC Core Cylinder	116
	NON-UL KD x 2 Keys x 1 Control Key		
P26D-D001X1U2	6 Pin Medeco® IC Core Cylinder	128	

HI-SECURITY™ CYLINDERS ARE PACKED 24 PER CASE

HI-SECURITY™
Cylinders

HI-SECURITY™ CYLINDERS





Security-Mate™ & SPECIAL APPLICATION CYLINDERS

Security-Mate™ MORTISE CYLINDERS				
	"0" Bitted "NO KEYS"		FINISH GROUPS	
	PART #	DESCRIPTION	3, 26D	4, 5, 10, 10B, 15, 26, 32D
	BXXX-DXXXXA0N0	1-1/8" Mortise Cylinder	56	61
	CXXX-DXXXXA0N0	1-1/4" Mortise Cylinder	61	65
	DXXX-DXXXXA0N0	1-3/8" Mortise Cylinder	72	78
	LXXX-DXXXXA0N0	1-1/2" Mortise Cylinder	84	49
	MXXX-DXXXXA0N0	1-3/4" Mortise Cylinder	95	101
Security-Mate™ CYLINDERS ARE PACKED 24 PER CASE				

Security-Mate™ MORTISE/RIM COMBO CYLINDERS				
	"0" Bitted "NO KEYS"		FINISH GROUPS	
	PART #	DESCRIPTION	3, 26D	4, 5, 10, 10B, 15, 26, 32D
	EXXX-DXXXXA0N0	1" Combo Cylinder	47	53
	FXXX-DXXXXA0N0	1-1/8" Combo Cylinder	61	65
	Security-Mate™ CYLINDERS ARE PACKED 24 PER CASE			

Security-Mate™ KIK CYLINDERS			
	"0" Bitted "NO KEYS"		FINISH GROUPS
	PART #	DESCRIPTION	26D
	G26D-DXXXXX0N0	Key-In-Knob Cylinder	44
Security-Mate™ CYLINDERS ARE PACKED 24 PER CASE			

Security-Mate™ MARKS IC CORE CYLINDERS			
	"0" Bitted "NO KEYS"		FINISH GROUPS
	PART #	DESCRIPTION	26D
	H26D-DXXXXX0N0	6 Pin IC Core Cylinder	49
	J26D-DXXXXX0N0	7 Pin IC Core Cylinder	53
Security-Mate™ CYLINDERS ARE PACKED 24 PER CASE			

Security-Mate® Schlage™ LARGE FORMAT IC CORE CYLINDERS			
	"0" Bitted "NO KEYS"		FINISH GROUPS
	PART #	DESCRIPTION	26D
	K26D-DXXXXX0N0	6 Pin Schlage® IC Core Cylinder	67
Security-Mate™ CYLINDERS ARE PACKED 24 PER CASE			

Security-Mate® Medeco™ LARGE FORMAT IC CORE CYLINDERS			
	"0" Bitted "NO KEYS"		FINISH GROUPS
	PART #	DESCRIPTION	26D
	P26D-DXXXXX0N0	6 Pin Medeco® IC Core Cylinder	86
Security-Mate™ CYLINDERS ARE PACKED 24 PER CASE			

HI-SECURITY™ SPECIAL APPLICATION CYLINDERS					
	KA Pair w/ 2 Keys, NON-UL, Straight Cam			FINISH GROUPS	
	PART #	DESCRIPTION	3, 26D	5, 15	
	2122XXXHSM	15/16" Mortise Cylinders	141	146	
HI-SECURITY™ SPECIAL APPLICATION CYLINDERS ARE PACKED 24 PER CASE					

HI-SECURITY™
Cylinders

HI-SECURITY™ CYLINDERS

HOW TO ORDER HI-SECURITY™ CYLINDERS AND KEYS

How To Order Example for HI-SECURITY™ Cylinders								
D	3	—	D	001	A	3	U	2
1. <i>Cylinder Type</i>	2. <i>Finish</i>	<i>Dash</i>	3. <i>Keyway</i>	4. <i>Security Code</i>	5. <i>Cam Tail</i>	6. <i>Keying</i>	7. <i>NON-UL / UL437</i>	8. <i># of Keys</i>

CYLINDER TYPE	FINISH	KEYWAY	SECURITY CODE	CAM TAIL <i>MORTISE</i>	KEYING	UL or NON-UL	KEYING
<input type="checkbox"/> B = 1-1/8" Mortise <input type="checkbox"/> C = 1-1/4" Mortise <input type="checkbox"/> D = 1-3/8" Mortise <input type="checkbox"/> L = 1-1/2" Mortise <input type="checkbox"/> M = 1-3/4" Mortise <input type="checkbox"/> E = 1" Combo <input type="checkbox"/> F = 1-1/8" Combo <input type="checkbox"/> G = KIK Cylinder <input type="checkbox"/> H = IC Core Marks 6 Pin <input type="checkbox"/> J = IC Core Marks 7 Pin <input type="checkbox"/> K = IC Core Schlage® Large Format <input type="checkbox"/> P = IC Core Medeco® Large Format	<input type="checkbox"/> 3 <input type="checkbox"/> 4 <input type="checkbox"/> 5 <input type="checkbox"/> 10 <input type="checkbox"/> 10B <input type="checkbox"/> 15 <input type="checkbox"/> 26 <input type="checkbox"/> 26D <input type="checkbox"/> 32 <input type="checkbox"/> 32D	<input type="checkbox"/> D = HS	<input type="checkbox"/> 001 = MARKS	<input type="checkbox"/> A = 2101 <input type="checkbox"/> B = 2102 <input type="checkbox"/> D = 2104 <input type="checkbox"/> E = 2105 <input type="checkbox"/> F = 2106 KIK <input type="checkbox"/> A = Standard Tail <input type="checkbox"/> B = Classroom Tail <input type="checkbox"/> C = i-Que Electronic IC CORE <input type="checkbox"/> A = 6 Pin IC <input type="checkbox"/> B = 7 Pin IC	<input type="checkbox"/> 0 = "0" Bitted <input type="checkbox"/> 1 = KD <input type="checkbox"/> 2 = KA <input type="checkbox"/> 3 = CMK <input type="checkbox"/> 4 = GMK <input type="checkbox"/> 5 = MK <input type="checkbox"/> 6 = GGMK	<input type="checkbox"/> U = UL 437 <input type="checkbox"/> N = NON UL	<input type="checkbox"/> 0 = "0" Bitted <input type="checkbox"/> 1 = 1 Key <input type="checkbox"/> 2 = 2 Keys <input type="checkbox"/> 3 = 3 Keys Up to 9, Then as separate line item

How To Order Example for HI-SECURITY™ Keys				
HS	6	D	001	C
1. <i>Key Type</i>	2. <i>Pins</i>	3. <i>Keyway</i>	4. <i>Security Code</i>	5. <i>Special Key Type</i>
KEY TYPE <input type="checkbox"/> HS = HI-SECURITY™ <input type="checkbox"/> RS = IC Core	PINS <input type="checkbox"/> 5 Pin <input type="checkbox"/> 6 Pin <input type="checkbox"/> 7 Pin	KEYWAY <input type="checkbox"/> D = HS	SECURITY CODE <input type="checkbox"/> 001 = Marks	SPECIAL KEY TYPE <input type="checkbox"/> C = Control Key

HI-SECURITY™
Cylinders







HI-SECURITY™ CYLINDERS









KEYS, CAMS & TAILPIECES

KEYS			
	PART #	DESCRIPTION	PRICE
	HS5D001	5 Pin Key Blank	8
	HS6D001	6 Pin Key Blank	8
	RS6D001	6 Pin IC Key Blank	8
	RS7D001	7 Pin IC Key Blank	8
	Schlage® IC CORE CONTROL KEY		
HSR3184	6 or 7 Pin IC Key Blank	8	
CUT KEYS			
Conventional Cylinder			11
IC Core Cylinder			11

KEYING CHARGES		
PART #	DESCRIPTION	PRICE
KA, KD	Keyed Alike, Keyed Different	NC
MK	Master Keyed	21
GMK	Grand Master Keyed	21
GGMK	Great Grand Master Keyed	21
VKC	Visual Key Control	14

MORTISE CYLINDER CAMS			
PART #	DESCRIPTION	PRICE	
 2101HS	Straight Cam	5	
 2102HS	Clover Cam	5	
 2104HS	Adams Rite Cam	5	
 2105HS	J - Cam	5	
 2106HS	G - Cam	5	
 2107-CLHS	Straight Cam	5	

Schlage® LARGE FORMAT IC CORE HOUSING CAMS			
PART #	DESCRIPTION	PRICE	
 2101 HSPM	Straight Cam	5	
 2102 HSPM	Clover Cam	5	
 2104 HSPM	Adams Rite Cam	5	
 2105 HSPM	J - Cam	5	
 2106 HSPM	G - Cam	5	
 2107-CL HSPM	Straight Cam	5	

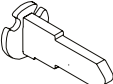
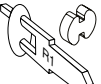
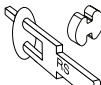
CYLINDRICAL TAIL PIECES			
PART #	FUNCTIONS	PRICE	
 F1903-C	AB, DW, F	7	
 F1903S-C	S, DA, DB, DC, SB, T	7	
IC CORE TAILPIECES			
 HR1984-HS	AB, B, DA (ext.), DW, F, FEU, FEL	7	
 HR1984S-HS	S, DA (int.), DB, DC, SB, T	7	

HI-SECURITY™
Cylinders

HI-SECURITY™ CYLINDERS



PARTS LIST

PARTS LIST			
PART #	DESCRIPTION	PRICE	PACKED
P2031	Finger Pins #1 (Silver)	25	25 per pack
P2032	Finger Pins #2 (Copper)	25	25 per pack
P2033	Finger Pins #3 (Black)	25	25 per pack
P2034	Finger Pins #4 (Gold)	25	25 per pack
P2035	Sidebar - Schlage® IC	25	25 per pack
P2036	Sidebar - Combo, KIK, Mortise	25	25 per pack
P2051	Sidebar - Best® IC	25	25 per pack
P2037	Sidebar Springs	25	50 per pack
P2044	Mortise Cam Screws	14	12 per pack
P2045	IC Mortise Cam Screws - SCHLAGE® ONLY	14	12 per pack
P2038	Hardened Steel Pins	14	12 per pack
P2041	Schlage® IC Cap Pin	25	12 per pack
P2042	Schlage® IC Cap Pin Spring	25	12 per pack
P2046	Schlage® IC Screw Cap	25	6 per pack
P2048	KIK Screw Cap	25	6 per pack
P2043	Best® IC Clip	25	12 per pack
P2039	Top Hex Screws (HI-SECURITY™ Mortise)	14	12 per pack
P2040	Top Hex Screws (HI-SECURITY™ Best® IC)	14	12 per pack
P2047	HI-SECURITY™ Registration Card	39	10 cards
R2984	7 Pin IC Tailpiece (AB, DW, F)	5	—
R2984S	7 Pin IC Tailpiece (S, DA, DB, DC, SB, T, TS)	5	—
R1981	Spacer	5	—
K2030	Parts Kit	277	—
2049	Plug Holder	39	—
BXXX-D133B1N1C	Cut Away Mortise Cylinder	107	—
BXXX-D133B1N1P	Plastic Mortise Cylinder	107	—
HSICT	Shear Tool	221	—
HSC387	HPC Card C387	49	—

HI-SECURITY™
Cylinders

SERIES M9900 EXIT DEVICE

RIM MOUNT



- EXTRUSION HEAVY GAGE 32D FINISH
- LIFETIME MECHANICAL WARRANTY
- PANIC PROTECTOR™ END CAP
- EASY INSTALLATION, ECONOMICAL



MARKS #	FUNCTION	PRICE	
		32D	10B
M9900	Rim Panic	419	488
M9900F	Fire Rated Rim Panic	473	542
M9900 - 48	Rim Panic - 48"	462	531
M9900F - 48	Fire Rated Rim Panic - 48"	517	586

OPTIONS	
M9900	33" Length for 38" Door
M9900-48"	42" Length for 48" Door

SPECIFICATIONS
• Doors: 1 3/4" thick standard
• End Cover: Stainless steel beveled "Panic Protector" design
• Strike: Roller strike
• Rail Assembly: Heavy Gauge Stainless Steel
• Dead latch Bolt: Stainless Steel 3/4" throw.
• Dead latch Bolt: Stainless Steel 5/8".
• Dogging feature: Allen Key (M9900)
• UL listed: For "Panic Hardware" and Fire Rated Model 3 hour fire doors up to 38" x 86".
• ANSI: ANSI 156.3 (2001), requirements for Grade 1
• 3 Hour Fire Rating
• Finished: Stainless steel satin finish

SERIES M9900 VR EXIT DEVICE

SURFACE VERTICAL ROD









APPLICATION
• For use on single door or pair of doors
• 1 3/4" (44 mm) door thickness standard. Specify thickness other than 1 3/4"
• RHR or LHR hollow metal, wood and mineral core doors
• Minimum Stile Width: 3 1/2" (89 mm)

MARKS #	FUNCTION	PRICE	
		32D	10B
M9900 VR	Rim Panic Vertical Rod	557	620
M9900F VR	Fire Rated Rim Panic Vertical Rod	613	682
M9900 - 48 VR	Rim Panic Vertical Rod - 48"	584	653
M9900F - 48 VR	Fire Rated Rim Panic Vertical Rod - 48"	640	705

SPECIFICATIONS
• Device Head Cover: Zinc alloy or stainless steel
• Chassis: Steel, plated
• Mechanism Housing: Extruded aluminum
• Push Bar Base: Extruded aluminum
• Touch Plate: Stainless Steel
• End Cap: Stainless Steel
• Top Latch: Stainless Steel 37/64" (14.8mm)
• Top Strike: Included
• Bottom Latch: Stainless Steel 37/64" (14.8mm)
• Bottom Strike: Included
• Latch Case Covers: Steel, stainless steel or brass
• Vertical Rods: Aluminum tube
• Hand: Non-handed
• Mounting: Machine screws standard. Sex bolts optional. Order "SNB" for wood or unreinforced metal doors
• Dogging: Allen-type key furnished
• Finish: 32D
• Outside Trim: Order separately
• Standard Height: 7' doors
• UL listed: ANSI/BHMA Grade 1 Panic Exit Hardware
• 3-Hour Fire Rated

Exit Devices

SERIES M9900 EXTERIOR TRIM

M411	Lever/Rose	Rim Panic Vandal Pull
		MVP/32D 
MES600A	Cylindrical Dogging Kit - 32D	Rim Panic Vandal Pull w/ cylinder hole
		MVPCC/32D (cylinder not included) 

ENTRY LEVER TRIM





- Standard Marks "C" Keyway KNK cylinder for panic device.
- Cylinder locks or unlocks lever, rigid when locked; when unlocked retracts latch bolt.
- Marks 26D Finish / Standard 1-3/4" Door Thickness
- IC Prep Code G1, Less Cylinder G3

ESCUTCHEON LEVER DESIGN

- Thru bolt design
- Non Handed design. Easily field reversible.
- Marks 32D Finish / Standard 1-3/4" Door Thickness
- Standard Marks "C" Keyway 1-1/4 Mortise cylinder with special cam
- IC Prep Code G1
- Less Cylinder G3

MARKS #	DESCRIPTION	PRICE	
		26D	10B
M411	Finger Pill - no cylinder	22	25
MESC600A	Lever / Escutcheon Trim Entry	128	170
MESC600F	Lever / Escutcheon Trim Storeroom	128	170
MESC600N	Lever / Escutcheon Trim Passage	111	154
MESC600DT	Lever / Escutcheon Trim Dummy Trim	111	154
M9901	36 inch Panic Device Dogging Kit	72	—
M9902	48 inch Panic Device Dogging Kit	80	—
MVR8	Vertical Rod 8 ft extension - Code 8	40	—
MVR10	Vertical Rod 10 ft extension - Code 10	64	—
MVRB	Vertical Rod - Bottom Rod	27	—
MVP/32D	Rim Panic Vandal Pull	191	—
MVPCC/32D	Rim Panic Vandal Pull w/ cylinder hole	212	—

MORTISE CYLINDER CAMS

M9907		MESC600A
M9908		MESC600F
M9909		MESC600F IC CORE HOUSING
M9910		MESC600A IC CORE HOUSING

SERIES M8800 EXIT DEVICE

THIN LINE TM RIM MOUNT

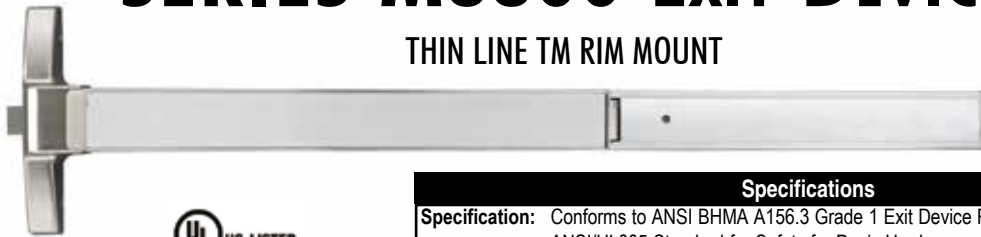

MARKS #	FUNCTION	PRICE
		32D
M8800	Rim Panic	466

Specifications	
Specification:	Conforms to ANSI BHMA A156.3 Grade 1 Exit Device Requirement Standard ANSI/UL305 Standard for Safety for Panic Hardware 2013 California Building Code Sec. 11B-309.4
For Doors:	(Please specify when ordering non standard size doors) Thickness: Standard 1 3/4", may fit with door thickness up to 2" Width: Standard 36" or 48", may fit door width 30"-48"
Mounting:	Furnished Standard with Wood and Machine Screws
Head Cover:	Zinc Alloy
Chassis:	Aluminum
Rail Assembly:	Heavy Gauge extruded aluminum with stainless steel on top of touch bar
End Cap:	Zinc Alloy
Hand:	Non-handed
Latch Bolt:	Stainless Steel, 3/4" (18mm) throw
Strike:	Roller Strike (Stainless Steel)
Dogging:	Allen Key (equipped on panic rate devices only)
Finish:	32D: Satin Stainless Steel Finish 10B: Oil Rubbed Bronze Finish
Dimension:	Touch bar height from finished floor: 41" (1041mm) from center of touch bar Touch Bar Projection: Neutral: 3 5/16" (84mm) Depressed: 2 19/32" (66mm) Head Cover: LxWxH: 206mm x 76mm x 71mm Device Length: 34 5/8" (88cm) for 36" door width 46 5/8" (118.5 cm) for 48" door width

Exit Devices

SERIES M195 EXIT DEVICE TRIM

Specifications

Levers: Solid cast Zamac, with 1/2" return (except 395 & 495)
Roses: Thru-bolted, 3-7/16" spring loaded Roses
Door Thickness: 1-5/8" – 1-7/8"
Clutch: Standard
Chassis: Aluminum
Cylinder: MARKS "C" keyway, 6 pin w/ 2 keys
 IC Core model - Core not included
Lifetime Mechanical Warranty

MARKS #	Trim	26D	19E
M195S/295/395/495	MLHL650S	159	201
M195F/295/395/495	MLHL650F	159	201
M195N/295/395/495	MLHL650N	148	180
M195DT/295/395/495	MLHL650DT	148	180

OPTIONS	CODE	PRICE - 195	295	395	495
Yale Conventional	F7	23	—	—	—
Sargent conventional cylinder	F8	23	22	—	—
Corbin conventional cylinder	F9	23	22	—	—
Corbin 6 pin IC core	F12	34	32	—	—
Corbin 7 pin IC core	F13	34	—	—	—
Yale 6 pin IC core	F14	23	22	—	—
Yale 7 pin IC core	F15	23	—	—	—
Schlage 6 pin IC core	F19	23	22	—	—
Sargent IC core	F20	23	22	—	—
Medeco IC core large format	F21	23	22	—	—
Less Cylinder	G3	Deduct 15	—	—	—

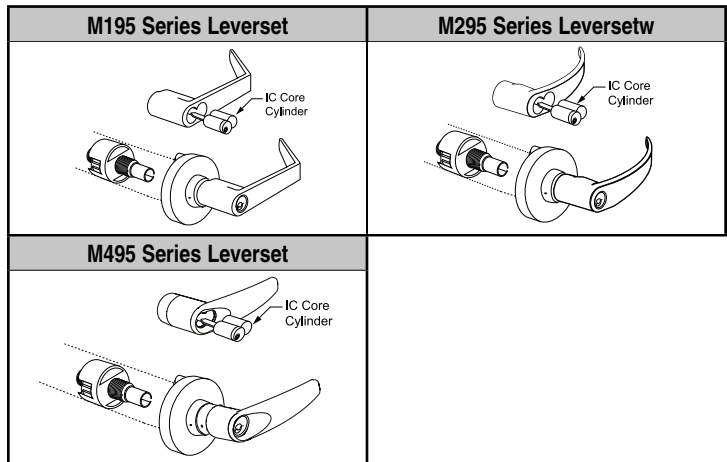

★ **Standard & HI-SECURITY™ IC Core Models:** Interchangeable Core models for 6 or 7 pin cores (not included). **Accepts:** Marks, Marks HI-SECURITY™, Medeco®, KeyMark™, Falcon, Schlage® small format & Best®. **IC Core Tailpieces ARE Included.**



ELECTRIC LATCH RETRACTION

WITH SIMULTANEOUS DOGGING

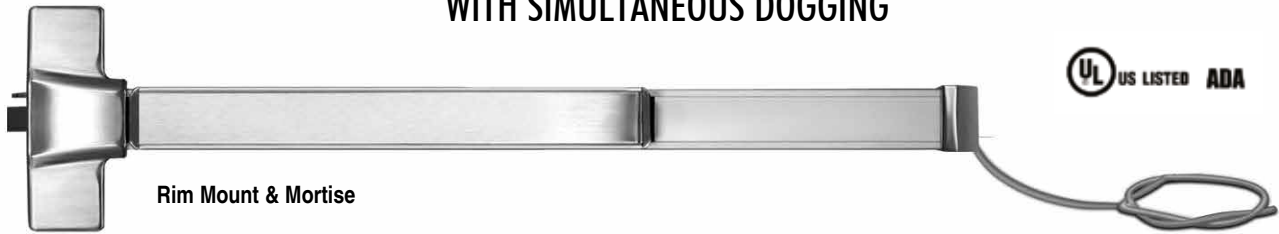

Rim Mount & Mortise



DEVICE SPECIFICATIONS	
ER	Electric Latch Retraction with simultaneous dogging
For:	M9900
Operation:	Momentary or maintained latch bolt and push pad retraction. Automatic re-triggering of latch retraction
Voltage:	24VDC @ 450 mA activation, 180 mA continuous
602RF	1 Amp power supply (1 EMC max)
632RF	2 Amp power supply (2 EMC max)
EMC	2-station sequencer required for automatic doors only.
Monitoring Available	Latch status and REX output available

MARKS #	DESCRIPTION	PRICE
HEAVY DUTY		
M9900ER	Electric Latch Retraction	2595
M9900ERP	Electric Latch Retraction w 602 Power Supply	3275

Exit Devices

EXIT ALARM

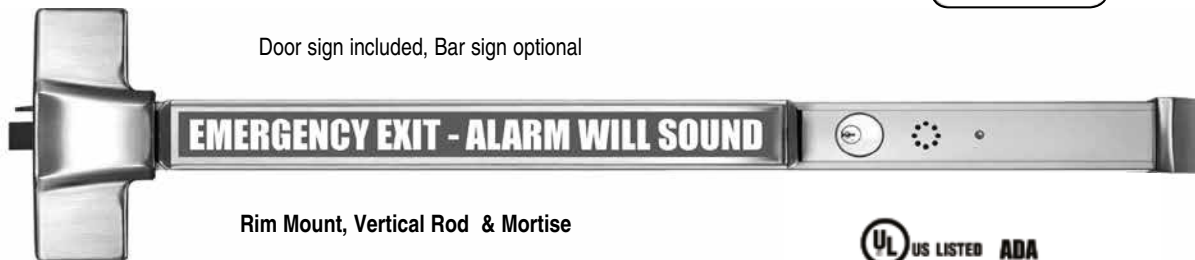

Door sign included, Bar sign optional

Rim Mount, Vertical Rod & Mortise



DEVICE SPECIFICATIONS	
EA	Exit Alarm, 9V battery powered
EB	Exit Alarm, 12-24V AC/DC input, 9V battery backup
For:	M9900
	<ul style="list-style-type: none"> • 100 dB alarm; visual and audible On/Off status: Armed - green LED blinks every 4 seconds, Alarm mode - red LED, Bypass - no LED • Remote status output • 15 or 60 second arming delay • 2 modes: Continuous alarm with manual key reset; Automatic re-arm 2 minutes after door closes with any manual key reset before 2 minutes.
Options:	<ul style="list-style-type: none"> • Push pad sign • 6, 10 & 20 minutes alarm; 1 or 5 second re-arm delay • Remote access control, arm, disarm inputs • REX and latch status outputs

MARKS #	DESCRIPTION	PRICE
HEAVY DUTY		
M9900EA	Exit Alarm 9VDC	1590
M9900EB	Exit Alarm 9VDC w 12/24 AC/DC Input	1630

ELECTRIC DOGGING



Rim Mount, Vertical Rod & Mortise

DEVICE SPECIFICATIONS
<p>DG Electric Dogging (failsecure) M9900, When energized by optional built-in or remote switch manual, depressing the pushpad, causes the pushpad and latch to remain retracted (unlocked) providing push-pull door operation. When de-energized or signaled by a fire alarm, the pushpad and latch are released.</p> <p>Voltage: 170/100 mA @ 12/24VDC</p> <p>Monitoring Available: Latch status and REX output available</p>

MARKS #	DESCRIPTION	PRICE
HEAVY DUTY		
M9900DG	Electric Dogging, Fail Secure	1820
M9900DGP	Electric Dogging, Fail Secure w 602 Power Supply	2500

DELAYED EGRESS



Rim Mount, Vertical Rod & Mortise

DEVICE SPECIFICATIONS	
DE	Wall mount delayed egress controller with keypad and electrified exit device, M9900, M9900VR
Example:	M9900F/32D-DE
DEK	Keypad controller with redundant key switch capable of all keypad control features
602RF	1 Amp power supply
	<ul style="list-style-type: none"> User PIN codes may be assigned to 1, 2 or all control functions. Reset, sustained bypass and momentary bypass (RES) Audible alarm voice release time, warning or safety message Visual display countdown, locked/unlocked, egress executed 15 or 30 second exit delay, 1 or 2 second nuisance delay 2 minutes
	Monitoring Available: Latch status available

MARKS #	DESCRIPTION	PRICE
HEAVY DUTY		
M9900DE	Delayed Egress	2595
M9900KDE	Delayed Egress w Keyswitch	2790
M9900DEP	Delayed Egress w 602 Power Supply	3275
M9900KDEP	Delayed Egress w Keyswitch W 602 Power Supply	3470
M9900VRDE	Delayed Egress	2865
M9900VRKDE	Delayed Egress w Keyswitch	2130
M9900VRDEP	Delayed Egress w 602 Power Supply	2610
M9900VRKDEP	Delayed Egress w Keyswitch W 602 Power Supply	2810

Exit Devices

M9900 LITE

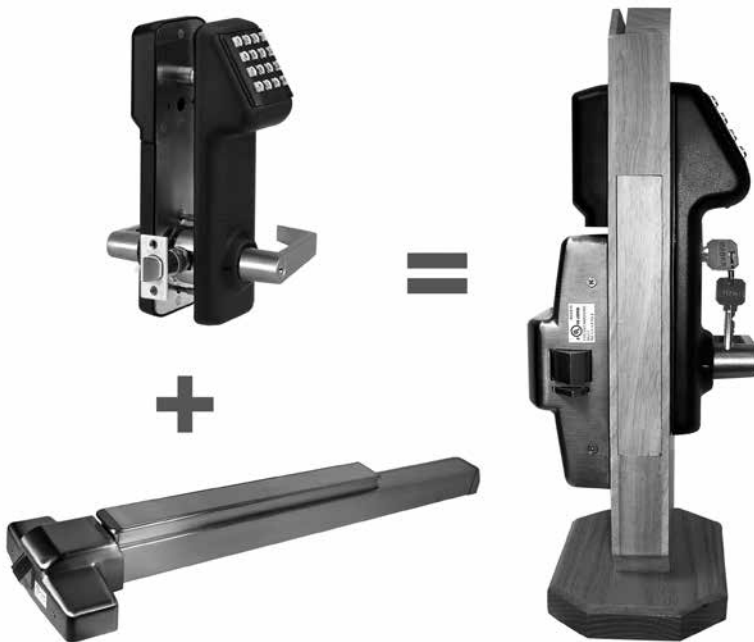

Adapter plate included

MARKS #	FUNCTION	PRICE
M9900LITE	Rim Panic with IQ7LITE	949

IQ7LITE

IQ7 LITE Rim Exit Device Interface Specifications

Door Thickness: 1-3/4" standard; For thicker doors, Consult factory

Handing: Non-handed

Key Override: 1-1/8" Mortise cylinder, 6 pin w/2 keys

Clutch: The "Clutch" for trouble free service

M9900

- **Doors:** 1-3/4" thick standard.
- **End cover:** Flush mounted beveled "Panic Protector" design.
- **Strike:** Roller strike.
- **Rail Assembly:** Extruded Aluminum, 32D finish.
- **Dead latch Bolt:** Stainless Steel 3/4" throw.
- **Dead latch Bolt:** Stainless Steel 5/8".
- **Dogging feature:** Allen Key (M9900)
- **UL listed:** For "Panic Hardware" and Fire Rated Model 3 hour fire doors up to 38" x 86".
- **ANSI:** ANSI 156.3 (2001), requirements for Grade 1.
- **3 Hour Fire Rating**
- **Finish:** 32D

POWER TRANSFER HINGE



10B Listed for 3hr Fire Rated Door

CODE	DESCRIPTION	PRICE
P1	Power Transfer Hinge MPTH - 4	156
P2	Power Transfer hinge MPTH - 10	205
PTH-4	Four conductor hinge	160
PTH-10	Ten conductor hinge	205

FEATURES

- UL10B Listed for 3 Hr Fire Doors. If the hinge you are presently using does not bear the F mark, it is not listed for use with fire doors.
- 500,000 cycles. 5 times UL test criteria
- Wire Replacement Warranty
- 5ft wire cable

APPLICATION

Installed in the center hinge position of the door, PTH Power Transfer Hinges provide the concealed wires required between the door and the frame, for the purpose of powering and monitoring electric door hardware.

- Electric Lock Power and Control
- Door and Lock Status Signaling
- Request-to-Exit Signaling

PTH-4 Four conductor hinge, 1 Amp @ 12/24V per pair, 4.5" x 4.5" five knuckle standard weight

PTH-10 Ten conductor hinge, 1 Amp @ 12/24V per pair, 4.5" x 4.5" standard weight

Consult factory for 3 knuckle, or special size

Finish

All base material steel
Aluminum, Duranodic, US 3, 10B, 26D & 32D finishes

Options

DPS Concealed Door Position Switch SPDT, 250mA @ 30VDC



FIRE RATED CONCEALED MORTISE POWER TRANSFER

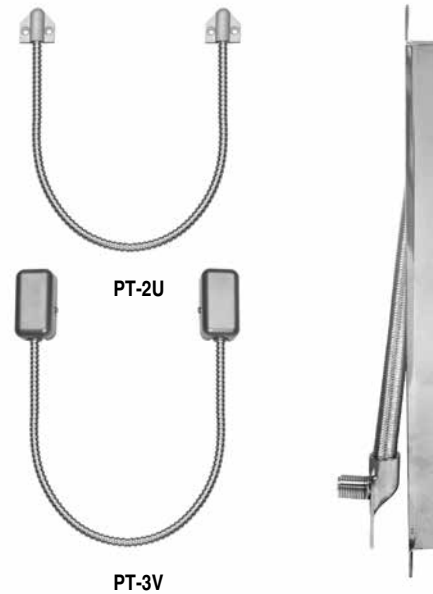

CODE	DESCRIPTION	PRICE
P3	Power Transfer loop MPT-2U	19
P4	Power Transfer Loop MPT-3V	42
PT-2U	Power Transfer Loop with end caps	25
PT-3V	PTL w/ aluminum wire termination box	50
PT-5	Concealed Mortise Power Transfer Loop	65
602 C	Access Control Power Supply and Charger	330

FEATURES

PT-5 Concealed Mortise Mount Power Transfer Loop

Frame mortised steel dust box with flexible steel loop and chrome finish. Recommended for use with hollow metal frames. UL Listed

Dimensions: 11.5"H x 1"W x 0.75"D (292 x 25.4 x 19mm)
10B Listed For 3 Hrs Fire Rated Doors



POWER TRANSFER LOOPS

18" (447mm) stainless steel armored flex conduit with small plastic end caps or termination box. Recommended for use with hollow metal and aluminum frames.

PT-2U With end caps

PT-3V With aluminum wire termination box

602 C POWER SUPPLY

Access Control Power Supply and Charger, Selectable 12/24VDC, 1 Amp, Emergency Release Input, Low Battery Disconnect, 12" x 12" x 4" Cabinet, UL, Class 2



Options: Key locked cover; 6 ft power cord; cover or interior mounted on-off switches; manual reset switches; 7 day, skip a day timer; Rechargeable batteries.

Multiple fuse protected outputs: Fuse modules provide protection for 4 or 8 individual circuits.

Dual 12 and 24VDC output capability: 12VDC voltage regulators enable dual 12 and 24VDC output capability for 12 and 24VDC components with one power supply.

Relay and Timer Modules: Relay and timer modules provide interface and control capability for single and multiple stations.

TOUCHLESS EXIT SWITCH

NO TOUCH WAVE-TO-EXIT SWITCH

For Sanitary Entry/Exit applications

DPDT Dry Contact Output • No Moving Parts • Bi-color Status Illumination



Red: Standby
474U
Price - 85



Green: Active
474DU
Price - 140

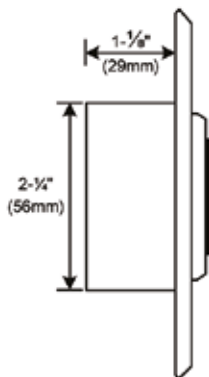

Side View

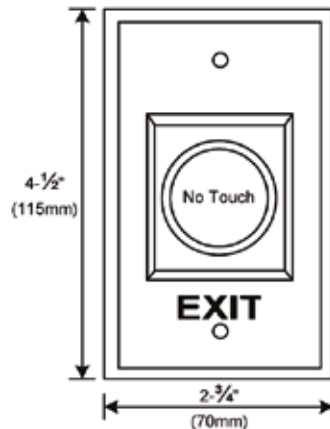

Front View

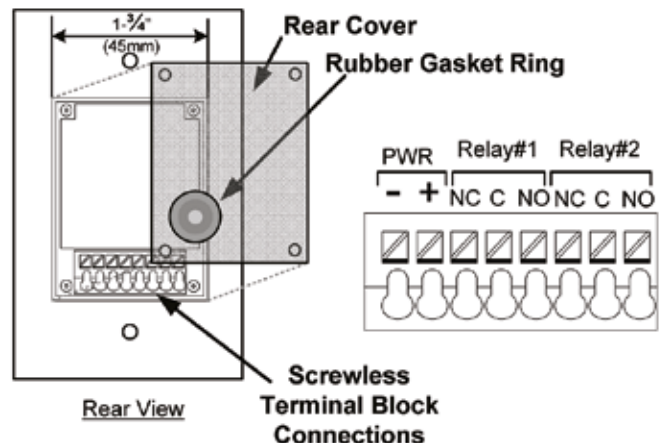

Rear View

Screwless Terminal Block Connections

SPECIFICATIONS

Input: 25mA (standby); 55mA (Active) @ 12/24VDC
Output: 2-SPDT, 3 Amp Dry Contact
Activation Time:
 1 second or as long as sensor is triggered
LED Color: Standby RED; Active Green
Range: 4" (10cm)
Weight: 3 oz. (85g)
Dimensions: 4.5" x 2.75" x 1.375"
 (115 x 70 x 35mm)

FEATURES & APPLICATIONS

- Uses IR Sensor technology; device is active with the simple wave of a hand
- Designed to control electric locks/strikes, magnetic locks, or automatic door operators
- Ideal for use in sanitary applications such as cleanrooms, bathrooms, food processing, hospitals and labs.
- Sensing Range up to 4" (10cm)
- Mounted on a durable stainless steel plate
- Dual LED, illuminated sensor, Red/Green indicates Inactive/Active status
- Quick connect screwless terminal block for easy installation

Touchless Exit Switch

How To ORDER PANIC DEVICES

CODE	OPTIONS	PRICE
P1	Power Transfer Hinge MPTH - 4	158
P2	Power Transfer hinge MPTH - 10	205
P3	Power Transfer loop MPT-2U	19
P4	Power Transfer Loop MPT-3V	42
P5	Latch Status	84
P6	REX	84
P7	Push Pad Sign	
P8	Keyswitch	84
POWER SUPPLY OPTIONS		
	FB-4 Fused Terminal board 4 individually fused outputs	42
P10	UR2-4 , Universal Controller for 2 doors. Field select TD, LR, TD/LR, mantrap A, B, C interlock. Two fused SPDT dry outputs, 5 Amp @ 30VD	231
P11	UR4-8 Universal Controller for 4 doors. Field select TD, LR, CR, TD/LR, mantrap A, B interlock. Four fused SPDT dry outputs, 5 Amp @ 30VDC. Four SPDT dry outputs, 1 Amp @ 30VDC. Two inputs per station, four auxiliary inputs.	326
P12	PSM Power Supply Monitoring Module For remote monitoring of power supply AC input, DC output and battery backup On/Off status. 2 SPDT Relay Outputs, 1 Amp @ 12/24VDC	231
UR1-V1	Universal Field Programmable Application Module	100
14-2	7 day programmable timer with memory battery back-up capability Output: 1 SPDT, dry contact Voltage: 16 Amps @ 30 VAC/DC Specify 12V AC/DC or 24 AC/DC	268
MRB12V4	12V/5Ah Battery. Specify in pairs for 24V	42
MRB12V7	12V/8Ah Battery Specify 2 for 24V	63
HEAVY DUTY SERIES ECLECTIC POWER TRANSFER DEVICE		
PTM-2AL	Two (2) 18 Ga. Conductor 5 Amp @ 12/24V Ac/Dc Aluminum Powder coated	376
PTM-10AI	Ten (10) 24GA wires 1 Amp @ 12/24V AC/DCA Aluminum Powder coated	376
TRIMS		
	Electric Trim for M9900 Features, Fail secure, Field Reversible to failsafe, Audible tone, 4Ft cable and connectors 600/300 Ma @ 12/24VDC	
SWITCHES		
M474U	Sanitary, No Touch wave to exit switch. IR sensor 4" read range Red, Green LED status, output DPDT 3 Amp dry cobtact input 25mA (stand by) 55mA (active) @ 12 VD, face plate 20ga Stainless steel	79
M422U	Momentary SPDT PUSH TO EXIT	74
M422AU	Momentary SPDT 2" Button - Blue illuminated lens only	74
M423U	Integrated electronic timer, adj. 1-60 sec 12/24VDC, 2A DPST Contact PUSH TO EXIT	130
M423AU	Integrated 1-60 sec Timer 12/24VDC, 2A DPST Contact 2" Button - Blue illuminated lens only Symbol	130
M424U	Momentary DPDT PUSH TO EXIT	110
M425U	AA (On/Off) DPDT NONE	110
MD-31D-W	PASSIVE INFRARED EGRESS CONTROL, Motion detector with time delay, white	247
MD-31D-B	PASSIVE INFRARED EGRESS CONTROL, Motion detector with time delay , black	247

ARCHITECH™ SERIES NETWORK LOCKS

Ideal access control solution; elegantly blending advanced wireless access control convenience within any decor, in attractive, infinitely customizable designer locking form, in choice of trims and finishes.



Features
<ul style="list-style-type: none"> • 5000 Users, 500 Scheduled Events & 40,000 Event Audit Trail • Surface-Mount or Mortised - in Electronics and Battery Pack • Lock available in Mortise and Cylindrical versions • Real Time Clock - Uses 4 AA Batteries – 3 to 4 year battery life • Operated via access card, fob, key fob etc • DL-Windows Software for programming • USB Radio Key Programming Method or Via Network Gateways • Manual Card Enrollment Option for Quick Installation • Wireless programming range: up to 20 ft. from lock
Specifications
<ul style="list-style-type: none"> • ANSI / BHMA Grade 1 Certified, UL Listed 3 Hours • Includes standard lever rose hardware design • Compatible with all 300+ optional architectural trim / lever or knob designs • Stainless steel latch, 2-3/4" backset • Auto-Reverse lock body tested to 6 million cycles • Lock Body - Self cleaning long life motor • Door closure monitor / electronic deadbolt monitor • Key override standard or high-Security • Optional integrated door position indicator switch

PRODUCT	PRICE
Cylindrical	
N90S2195F26D	933
N90S1195F26D	933
Mortise	
N95S2RX92FD26D	1166
N95S1RW86FD26D	1166

Mounted Samples

PRODUCT	PRICE
Cylindrical	
N90S1295SK26D	consult factory
S90S1195SK26D	consult factory
N90S1195SK26D	consult factory
Mortise	
N95S1RW86SK26D	consult factory

ArchiTech™ Series Network Locks Parts and Accessories

PRODUCT	DESCRIPTION	PRICE
AL-IME	Ethernet connected gateway w/AC adapter to plug into standard wall outlet	541
AL-IM80211	Wi-Fi gateway to connect to 802.11 network w/AC adapter to plug into standard wall outlet.	753
AL-IMEPOEP	Power Over Ethernet, plus hardwire gateway interface capability. No AC Power required.	647
AL-IME-USB	USB Gateway	318
AL-NSM	Network Signal Meter	314
ALHID1326	Proximity Access Cards 100 Per Box	535
ALHID1336	Proximity, Magnetic Stripe and Photo ID cards 100 per box	1092
ALHID1386	Proximity and Photo ID Card 100 per box	983
ALHID1391	MicroProx Tag 10 per box	87
ALHID1346	Proximity keyfob 10 per box	125

ArchiTech Series Network Locks

ARCHITECH™ SERIES NETWORK LOCKS

Standard Model Ordering. Infinite Custom Models available. Call Factory For Ordering Assistance.

Special Order

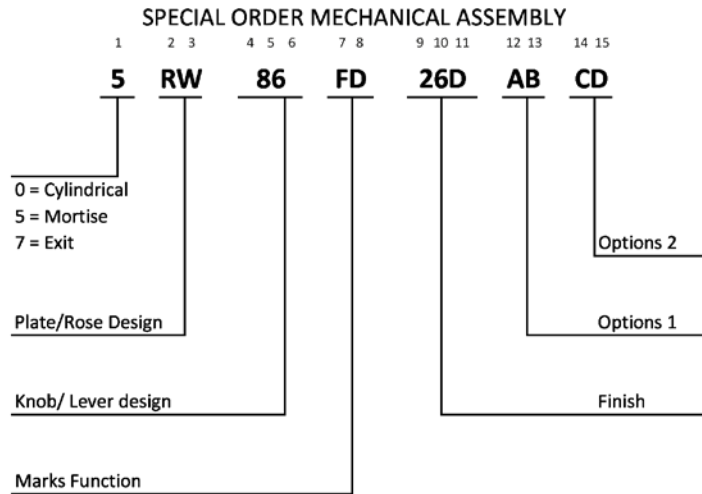
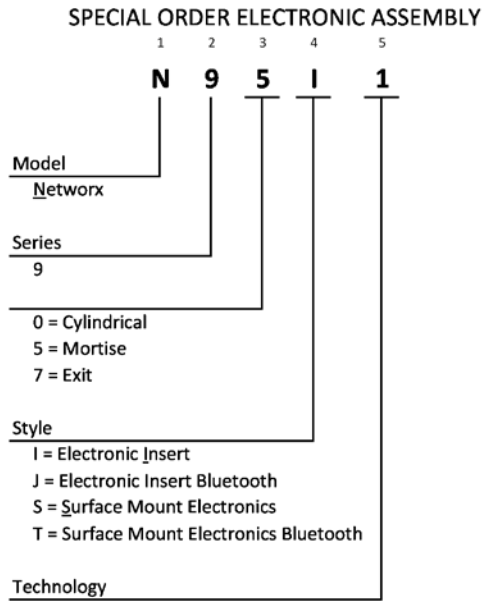

- 1 = Prox Oval
- 2 = Prox Square
- 3 = Mag Stripe Oval
- 4 = Mag Stripe Square
- 5 = Keypad Oval
- 6 = Keypad Square
- 7 = Keypad Prox Oval
- 8 = Keypad Prox Square
- 9 = Keypad Mag Stripe Oval
- 0 = Keypad Mag Stripe Square
- A = Smart Oval (iClass® Technology)
- B = Smart Square (iClass® Technology)
- C = Concealed Prox

ARCHITECH™ SERIES NETWORK LOCKS

Standard Model Ordering. Infinite Custom Models available. Call Factory For Ordering Assistance.

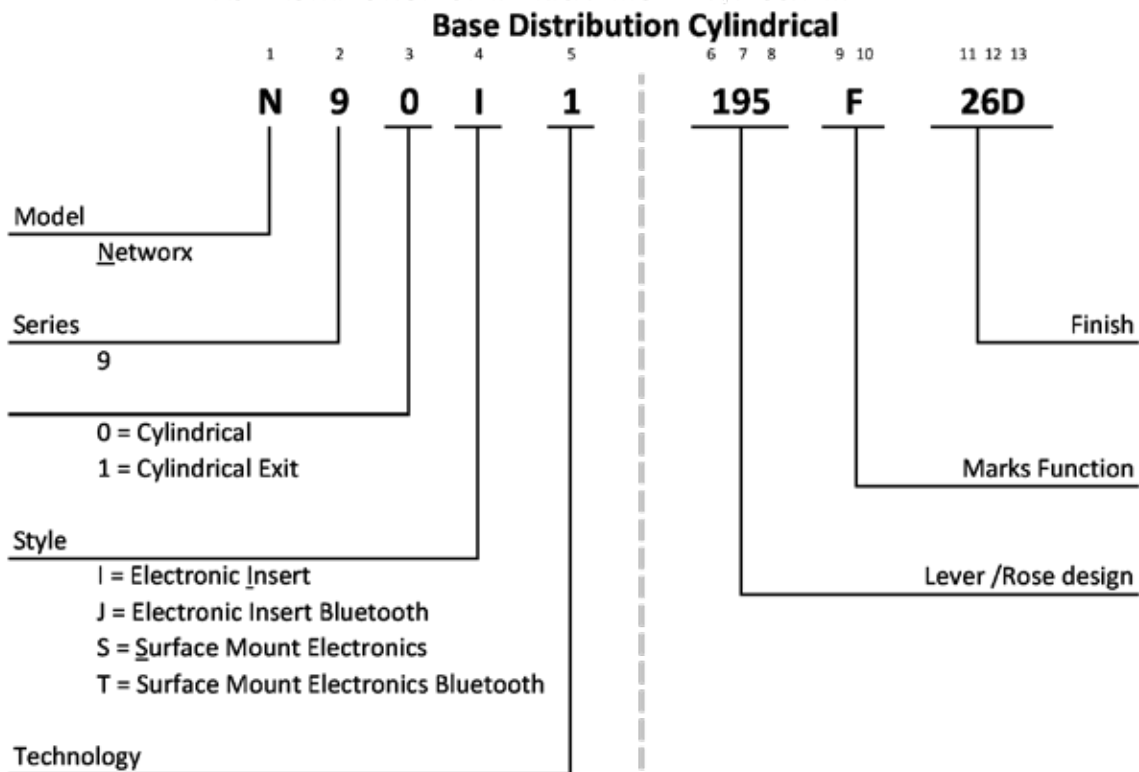
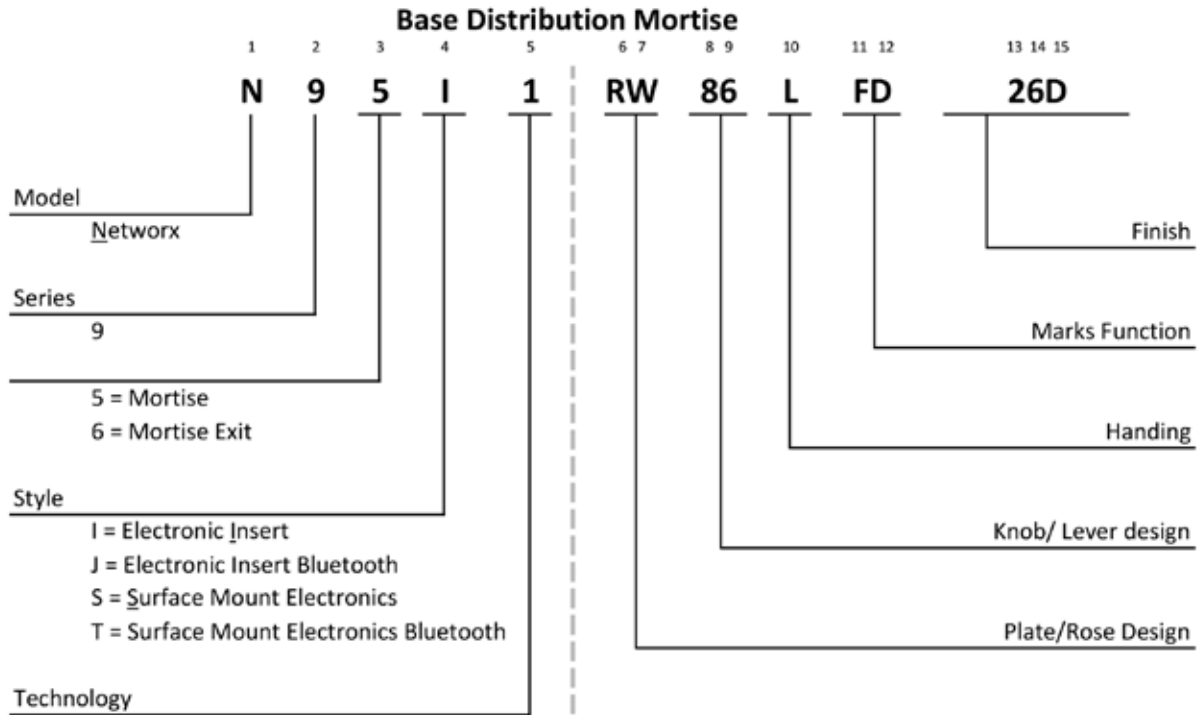

Architech Series
Network Locks



MARKS USA

AMITYVILLE, N.Y. 11701

www.marksusa.com

DISTRIBUTED BY:

800-645-9445 • FAX 631-225-6136